

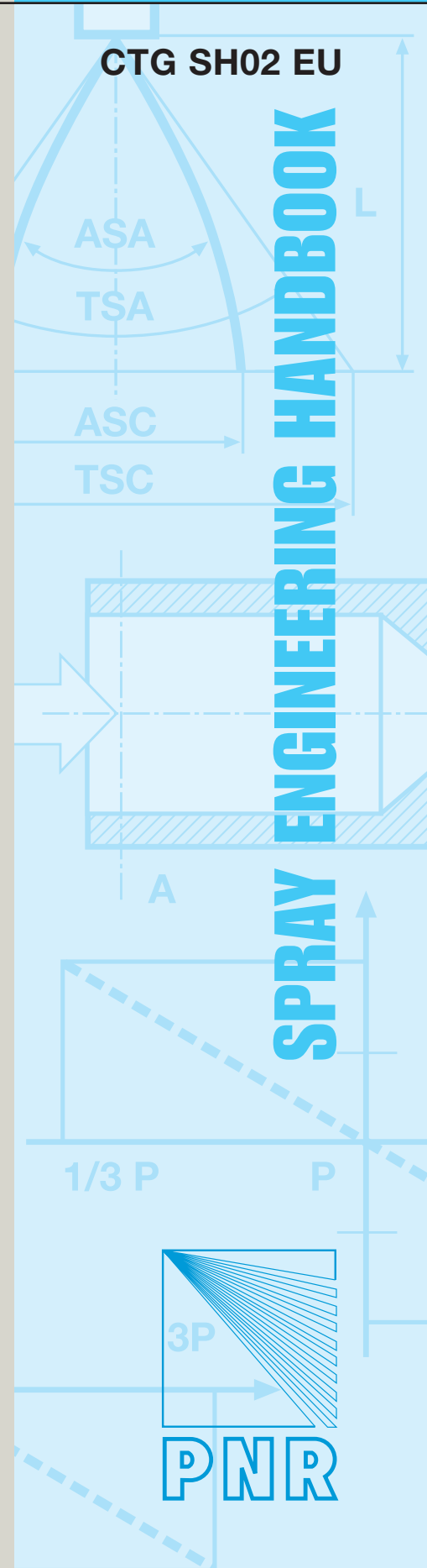

SPRAY ENGINEERING HANDBOOK



INDEX

INTRODUCTION	1
Euro and American units	2
Temperature units	4
Fractions of inch	5
LIQUID SPRAY	5
Spray Generation	6
Droplet Spectrum	7
NOZZLE APPLICATION FORMULAS	
Nozzle flow rate	10
Spray angle	12
Viscosity	14
Specific gravity	16
Impact of a water jet	17
NOZZLE MATERIALS	
PNR material code	19
Common nozzle material	20
Mechanical properties	24
Chemical resistance	25
PIPING	
Common flange standards	31
Economic pipe size	33
Water velocity in pipe	34
PNR PRODUCT RANGE	37

TECHNICAL PUBLICATIONS

PNR manufactures a complete range of spray nozzle for industrial application, and several! products and systems based on spray technology.

Our complete product range is described by the following catalogues:

PRODUCT RANGE	CTG TV 10 BR
SPRAYNOZZLES FOR INDUSTRIAL APPLICATIONS	CTG UG 16 BR
AIR ASSISTED ATOMIZERS	CTG AZ 15 BR
COMPLEMENTARY PRODUCTS & ASSEMBLY FITTINGS	CTG AC 16 BR
TANK WASHING SYSTEMS	CTG LS 15 BR
PAPERMILL NOZZLES	CTG PM09 BR
EVAPORATIVE COOLING NOZZLES	CTG LN 16 BR
STEELWORK NOZZLES	CTG SW11 BR
SPRAYDRY NOZZLES	CTG SD 10 BR
FIRE FIGHTING PRODUCTS	CTG FF 10 BR

Our technical publications are continuously updated, and mailed to Customers whose name and address are registered into our Catalogue Mailing List.

We shall gladly register your name, if you mail to the nearest PNR office the form on page 39, duly filled with the required information

Disclaimer

These informations are provided "as is" and PNR makes no warranty of any kind with respect to the subject matter or accuracy of the information contained herein. This publication may include technical inaccuracies or typographical errors. Changes may be periodically made to the information herein without previous notice.

INTRODUCTION

Euro and American units	2
Temperature units	4
Fractions of inch	5

FOREWORD

Along many years PNR engineers have been involved with Customers to find out the appropriate solution to specific application problems in numberless different industries. This continuous cooperation has allowed us to gather a large quantity of information regarding practical spray nozzles applications, which we make available every day to our Customers. We like to thank all our Customers for their past cooperation, and for the invaluable help they have given us in designing and manufacturing an always more complete and efficient range of spray nozzles and spraying systems. To make this information readily available, and improve our service, we have now decided to gather and organize it within a manual. We hope the reader will appreciate our work, and welcome any suggestion or addition which may lead to improve and complete this manual.

INTERNATIONAL SYSTEM OF UNITS

DESCRIPTION

The **INTERNATIONAL SYSTEM OF UNITS** sometimes called SI, has been defined by the International Standards Organization (ISO) and is based upon metric units. The following notes include most units which are likely to be used in handling of fluids. The system consists of nine base units, and supplementary units which are coherently derived from them. The coherence consists in the fact that the product, or the quotient of any two unit quantities in the system result in another unit quantity. Because of the world wide trend to use this modern metric system, we are providing in the following the conversion constants for the most useful units.

BASE UNITS AND DERIVED UNITS

The SI has defined the following base unit:

N°	QUANTITY UNIT	NAME UNIT	SYMBOL	
1	Length	meter	m	
2	Mass	kilogram	kg	
3	Time	second	s	
4	Thermodynamic temperature	Kelvin	K	
5	Molecular substance	mole	mol	
6	Electric current	Ampere	A	
7	Light intensity	candela	cd	
8	Plane angle	radian	rad	
9	Solid angle	steradian	sr	

Out of these base units many other have been derived, the most interesting for our purposes being listed below.

N°	QUANTITY UNIT	NAME UNIT	SYMBOL	
10	Area	square meter	m ²	
11	Volume	cubic meter	m ³	
12	Density	kilogram per cubic meter	Kg/m ³	
13	Velocity	meter per second	m/s	
14	Acceleration	meter per second squared	m/s ²	
15	Angular velocity	radian per second	rad/s	
16	Frequency	Hertz	Hz	Hz = cycles/s
17	Force	Newton	N	N = kg • m/s ²
18	Pressure	Pascal	Pa	Pa = N/m ²
19	Momentum	kilogram meter per second	Kg m/s	
20	Energy	Joule	J	J = N • m
21	Power	Watt	W	W = J/s
22	Moment of force	Newton meter	N m	
23	Kinematic viscosity	square meter per second	m ² /s	
24	Dynamic Viscosity	Pascal second	Pa s	
25	Thermal conductivity	Watt per meter Kelvin	W/(m•K)	

CONVERSION TABLE: AMERICAN UNITS TO SI UNITS

QUANTITY	AMERICAN UNIT	CONVERSION FACTOR	SI UNIT
DENSITY	Pound mass/cubic feet	16.018	kilograms/cubic meter
FLOW RATE	Gallons per minute	3.785	liters per minute (lpm)
FLUID VOLUME	US Gallon	3.785	liter (l)
FORCE	Pound force	4.448	Newton (N)
HEAT	BTU (British Thermal Unit)	1055	Joule (J)
HEAT TRANSFER	BTU per hour	0.2931	Watt (W)
SPECIFIC HEAT CAPACITY	BTU per pound*deg F	4184	Joule / (kg K)
LENGHT	mil	25.4	Micrometer (micron)
LENGHT	Inches	25.4	millimeters (mm)
LENGHT	Foot	0.3048	meter (m)
POWER	Horsepower	0.746	kilowatt (kW)
PRESSURE	Pounds per square inch	0.0689	bar (1 bar = 100 kPa)
CALORIC VALUE, ENTALPY	BTU per pound	2326	Joule per kg
SPECIFIC WEIGHT	Lbs per gallon	0.1198	kg per liter (kg/l)
SURFACE	Square inch	6,4516	square centimeter (cm ²)
SURFACE	Square foot	0,0929	square meter (m ²)
SURFACE	Acres	0.4047	hectares (ha)
VELOCITY	Foot per second	0.3048	meters per second (m/sec)
VELOCITY	Foot per minute	0.3048	meters per minute (m/min)
VELOCITY	Miles per hour	1.609	kilometers per hour (km/h)
VELOCITY	Knots	1.852	Kilometers per hour (km/h)
VOLUME	Cubic foot	0.0283	cubic meter (m ³)
VOLUME	Cubic inch	16.387	cubic centimeter (cm ³)
WEIGHT	Pound	0.4536	kilogram (kg)
WEIGHT	Ton	0.9072	metric ton (t)

Multiply American Units on the left (by the conversion factor) to obtain SI Units on the right.

Divide SI Units on the right (by the conversion factor) to obtain American Units on the left.

CONVERSION TABLE: TEMPERATURE SCALES

There are 4 principal type of temperature scale used for indicate the temperature: CENTIGRADE CELSIUS, FAHRENHEIT, KELVIN, and RANKINE; Kelvin and Celsius scales are used in Europe, Rankine, Fahrenheit are used in Anglo-Saxons countries.

SYMBOL	NAME	MP	BP	NOTES
°C	Centigrade	0	100	0 and 100 are arbitrarily placed at the freezing point and boiling points of water.
°F	Fahrenheit	32	212	0°F is the stabilized temperature when equal amounts of ice, water, and salt are mixed. 96°F is the temperature "when the thermometer is held in the mouth or under the armpit of a living man in good health."
K	Kelvin	273.16	373.16	Based upon the definitions of the Centigrade scale and the experimental evidence that absolute zero is -273,16° C and that is an international standard temperature point.
°R	Rankine	491.67	671.67	Based upon the definitions of the Fahrenheit scale and the experimental evidence that absolute zero is -273,16° C

CONVERSION FORMULAE TABLE

	CELSIUS	FAHRENHEIT	KELVIN	RANKINE
°C=	-	$\frac{°F - 32}{1,8}$	K - 273,16	$\frac{R}{1,8} - 273,16$
°F=	1,8 °C + 32		1,8-K - 459,69	R - 459,69
K=	°C + 273,16	$\frac{°F - 32}{1,8} + 273,16$	-	$\frac{R}{1,8}$
°R=	1,8 (°C + 273,16)	°F + 459,67	1,8-K	-

°C	°F	°C	°F	°C	°F	°C	°F	°C	°F
-10	14	19	66,2	43	109,4	67	152,6	91	195,8
-8	17,6	20	68	44	111,2	68	154,4	92	197,6
-6	21,2	21	69,8	45	113	69	156,2	93	199,4
-4	24,8	22	71,6	46	114,8	70	158	94	201,2
-2	28,4	23	73,4	47	116,6	71	159,8	95	203
0	32	24	75,2	48	118,4	72	161,6	96	204,8
1	33,8	25	77	49	120,2	73	163,4	97	206,6
2	35,6	26	78,8	50	122	74	165,2	98	208,4
3	37,4	27	80,6	51	123,8	75	167	99	210,2
4	39,2	28	82,4	52	125,6	76	168,8	100	212
5	41	29	84,2	53	127,4	77	170,6	105	221
6	42,8	30	86	54	129,2	78	172,4	110	230
7	44,6	31	87,8	55	131	79	174,2	115	239
8	46,4	32	89,6	56	132,8	80	176	120	248
9	48,2	33	91,4	57	134,6	81	177,8	125	257
10	50	34	93,2	58	136,4	82	179,6	130	266
11	51,8	35	95	59	138,2	83	181,4	135	275
12	53,6	36	96,8	60	140	84	183,2	140	284
13	55,4	37	98,6	61	141,8	85	185	145	293
14	57,2	38	100,4	62	143,6	86	186,8	150	302
15	59	39	102,2	63	145,4	87	188,6	160	320
16	60,8	40	104	64	147,2	88	190,4	170	338
17	62,6	41	105,8	65	149	89	192,2	180	356
18	64,4	42	107,6	66	150,8	90	194	190	374

METRIC AND DECIMAL EQUIVALENTS OF FRACTIONS OF ONE INCH

mm	FRACTIONS OF ONE INCH						INCHES
0,3969						1/64	0,015625
0,79375					1/32		0,03125
1,1906						3/64	0,04687
1,5875				1/16			0,0625
1,9844						5/64	0,078125
2,38125					3/32		0,09375
2,7781						7/64	0,109375
3,1750			1/8				0,125
3,5719						9/64	0,14062
3,96875					5/32		0,15625
4,3656						11/64	0,171875
4,7625				3/16		13/64	0,1875
5,1594							0,203125
5,55625					7/32		0,21875
5,9531						15/64	0,234375
6,3500		1/4					0,25
6,7469						17/64	0,265625
7,14375					9/32		0,28125
7,5406						19/64	0,29687
7,9375				5/16			0,3125
8,3344						21/64	0,328125
8,73125					11/32		0,34375
9,1281						23/64	0,359375
9,5250			3/8				0,375
9,9219						25/64	0,390625
10,31875					13/32		0,40625
10,7156						27/64	0,42187
11,1125				7/16			0,4375
11,5094						29/64	0,453125
11,90625					15/32		0,46875
12,3031						31/64	0,484375
12,7000	1/2						0,5
13,0969						33/64	0,515625
13,49375					17/32		0,53125
13,8906						35/64	0,54687
14,2875				9/16			0,5625
14,6844						37/64	0,578125
15,08125					19/32		0,59375
15,4781						39/64	0,609375
15,8750			5/8				0,625
16,2719						41/64	0,64062
16,66875					21/32		0,65625
17,0656						43/64	0,671875
17,4625				11/16			0,6875
17,8594						45/64	0,703125
18,25625					23/32		0,71875
18,6531						47/64	0,734375
19,0500		3/4					0,75
19,4469						49/64	0,765625
19,84375					25/32		0,78125
20,2406						51/64	0,796875
20,6375				13/16			0,8125
21,0344						53/64	0,828125
21,43125					27/32		0,84375
21,8280						55/64	0,85937
22,2250			7/8				0,875
22,6219						57/64	0,890625
23,01875					29/32		0,90625
23,4156						59/64	0,921875
23,8125				15/16			0,9375
24,2094						61/64	0,953125
24,60625					31/32		0,96875
25,0031						63/64	0,984375
25,4000	1						1,0

LIQUID SPRAY

LIQUID SPRAY

Spray generation	6
Droplet spectrum	7

SPRAY GENERATION

The diagram below shows the idealization of the process generating the droplets while the water lamina exiting the nozzle is breaking up.

The theoretical model, whose exactitude seems to be confirmed by scientific research, considers that the liquid flowing through the nozzle and past the orifice edge evolves into a liquid lamina.

This lamina, because of instability induced by aerodynamic forces, breaks up first into elongated ligaments more or less cylindrical, and later into droplets.

Taking this model as a guideline, one can easily appreciate that the average droplet diameter is some what related to several factors, like:

1. The thickness of the lamina itself
2. The evenness of the lamina
3. A steady flow and break up process

For what has been said above, and limited to hydraulic nozzles, the system designer looking for fine droplet sprays should consider that the following results can be expected

Impact nozzles	best
Centrifugal hollow cone nozzles, multiple full cone nozzles	good
Turbulence nozzles	fair
Centrifugal Vaneless full cones	worst

**Theoretical model
of droplet generation**

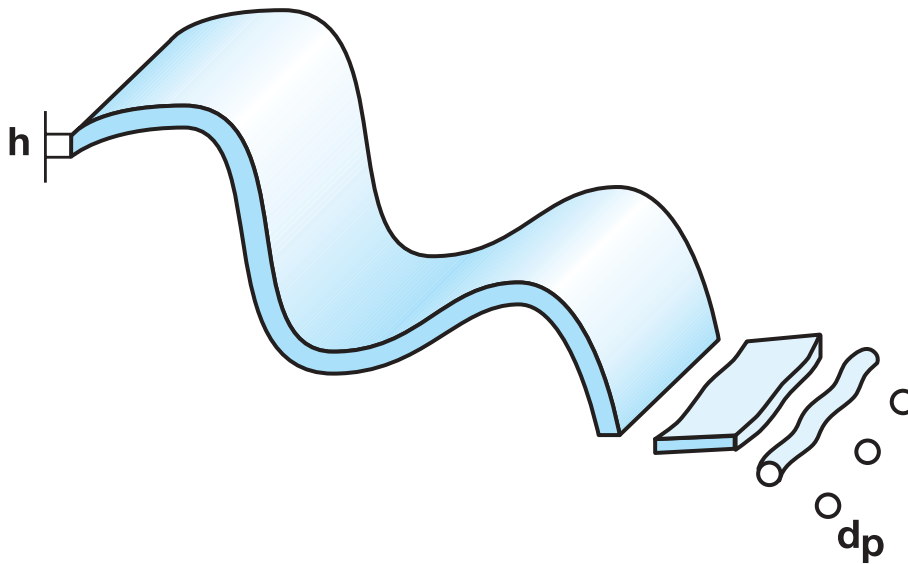

In cases where energy requirements are not a problem, or where a specified small droplet diameter is required, the smallest droplets can be obtained by means of an air assisted atomizer.

Here the shear action of a high speed compressed air flow is used with several different techniques to SMD (Sauter Mean Diameter) of 20 microns and less.

See our Air Assisted Atomizers Catalogue for more detailed information about droplet sizing, and the related parameters.

DROPLET SPECTRUM

The atomization of a liquid by means of a compressible fluid like air, steam or a gas, is defined pneumatic, two-phase, or twinfluid atomization. Many industrial processes require the availability of finely atomized droplets and the techniques to produce atomized jets have been largely improved in the recent years. In addition, more sophisticated process techniques have increase the demand for a precise definition about the characteristics of the spray and are now available to the design engineer. Since many years PNR can supply upon request complete documentation containing test reports about the more interesting information, which is described below.

LASER INTERFEROMETER TEST (PDPA)

PNR droplet size test reports are performed by means of a Laser Interferometer (Phase Doppler Particle Analyzer), where two laser beams cross in a given point of the spray and define a test probe area. Droplet flying through the probe area cause a light scatter which is picked up by the instrument receiver and processed through a computer, in order to obtain relevant information about the spray characteristics.

REPORT INFORMATION

Report information is made of data printed on three pages, where the first page contains the most interesting data which make possible to base process calculations upon precise data about spray characteristics, process efficiency and jet behavior in operational ambience. Of primary importance the Sauter Mean Diameter value for heat exchange calculations about evaporative gas cooling processes, since it gives the possibility of evaluating the exchange surface obtained by atomizing a given liquid volume.

The upper picture at page 8 shows:

- Distribution curve of droplet diameter (micron)
- Distribution curve of droplet velocities (mps) and the below described values
- In addition the following values are given
- Arithmetic Mean Diameter (D_{10})
- Surface Mean Diameter (D_{20})
- Volume Mean Diameter (D_{30})
- Sauter Mean Diameter (D_{32}).

ARITHMETIC MEAN DIAMETER (D_{10})	This is a diameter value which, multiplied by the local number of droplets in the sample, equals the addition of all droplets diameters.	$D_{10} = \sqrt{\frac{\sum_1^n d_i}{n}}$
SURFACE MEAN DIAMETER (D_{20})	This is the diameter of such a droplet whose surface, multiplied by the total droplets number, equals the sum of all droplets surfaces.	$D_{20} = \sqrt{\frac{\sum_1^n d_i^2}{n}}$
VOLUME MEAN DIAMETER (D_{30})	This is the diameter of such a droplet whose volume, multiplied by the total droplets number, equals the sum of all droplets volumes.	$D_{30} = \sqrt{\frac{\sum_1^n d_i^3}{n}}$
SAUTER MEAN DIAMETER (D_{32})	This is the diameter of such a droplet whose volume/area ratio, equals the ratio between the sum of all droplet volumes divided by the sum of all droplet surfaces.	$D_{32} = \sqrt{\frac{\sum_1^n d_i^3}{\sum_1^n d_i^2}}$

DROPLET SPECTRUM

ATTEMPTS

Droplet number crossing probe area during test time. This includes both validated and not validated droplets.

CORRECT COUNT CRITERIA

A mathematic correction is applied to validate droplets which cross Probe Area in a peripheral belt, or to droplets without a perfect spherical shape. So that all validated droplets parameters are homogeneous. (This correction is necessary so that there is direct proportionally between laser beam phase and droplet number diameter).

NUMBER DENSITY

It is the number of droplets passing through probe area within test time.

PROBE AREA

This is the area where the two laser beams are crossing, so determining the probe area. All drop-lets intersecting probe area are checked. droplets which respect given parameters for shape are taken as valid droplets and make up the sample, whose size and velocity parameters are reported.

RUN TIME

Droplets distribution speed histogram (m/s).

VALIDATIONS

Droplets accepted, based on given shape parameters. to make up for test sample.

VELOCITY MEAN

Droplets distribution speed histogram (m/s).

VOLUME FLOW RATE

It is the volume, measured in cubic centimeter per second, of the validated droplets making up for the sample.

VOLUME FLUX

It is the flow rate per specific area, measured in cubic centimeter per second and square centimeter, of the validated droplets making up the sample.

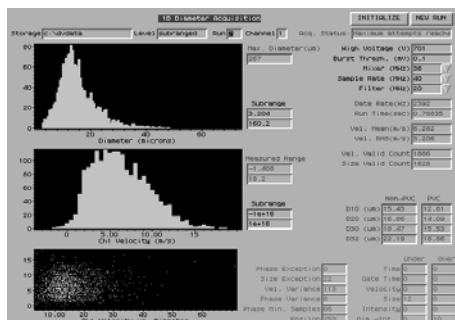

PNR can supply upon request complete documentation containing test reports about the aforementioned parameters and additional information, for all PNR atomizers.

The diagrams beside show the distribution of droplet diameters and droplet velocities of a spray under test as available to our customers.



In the photo beside a test being performed at our laboratories. We use a computer driven laser interferometer to detect and record the spray parameters, while fluid capacities and feed pressure values are monitored through high precision instruments.

NOZZLE APPLICATION FORMULAS

NOZZLE APPLICATION FORMULAS

Influence of pressure on nozzle flowrate	10
Discharge coefficient	11
Nozzle spray angle	12
Viscosity	14
Specific gravity	16
Jet impact	17

A nozzle is a device which converts the energy from a fluid into velocity of the spray droplets.

Applications in many industrial processes are numberless, with spray nozzles being very often a critical component in determining the final quality of the product or the efficiency of the process.

For this reason the available nozzle range types for industrial applications can be found in PNR nozzle catalogue, as well as a concise but complete information about the most important parameters which can give a technical definition of a spray and its quality.

We have grouped in the following the most useful formulas for designing a spray system, showing the influence of the different factors which can affect the process of spraying.

More information about the working life of a nozzle and the best suited material for a given purpose can be found at page 17 of this publication.

All the following data, when not otherwise specified, refer to spraying water at 20° C.

NOZZLE FLOW RATE

In order to calculate the discharge flow rate from a given nozzle the Bernoulli law shall be used, which says that the energy of a liquid flow remains unchanged over all the sections of the flow. Friction and turbulence losses are neglected, which is reasonable for our purposes if the calculation is performed over two sections not too far away from each other.

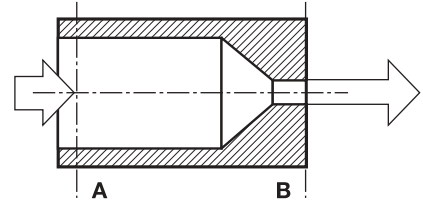

The energy of a given liquid flow crossing a given pipe section is composed of three parts, namely:

P Pressure energy of liquid particle per volume unit

$\frac{1}{2} \rho V^2$ Kinetic energy of liquid particle per volume unit

$\rho g z$ Potential Energy of liquid particle per volume unit

Where ρ = density of liquid particle, g = gravitational acceleration,

z = height respect to one plane of reference, V_2 = liquid particle velocity

The Bernoulli law can be written as follows

$$\mathbf{1} \quad P + \frac{1}{2} \rho V^2 + \rho g z = K$$

Therefore, if we consider two sections of the same pipe, section A and section B, we can write that the flow energy remains constant in the form:

$$\mathbf{2} \quad P_A + \frac{1}{2} \rho V_A^2 + \rho g z_A = P_B + \frac{1}{2} \rho V_B^2 + \rho g z_B$$

If we finally consider that the two above sections are taken immediately before and immediately after the nozzle outlet orifice, being:

- $Z_A = Z_B$
- $P_B = 0$ (P_A is a differential pressure referred at the atmosphere pressure)
- $V_A \cong 0$ negligible as compared to V_B (for orifice diameter very smaller than the duct diameter)

we shall come to the formula of the **EXIT VELOCITY** from the nozzle:

$$P_A = \frac{1}{2} \rho V_B^2 \Rightarrow V_B = \sqrt{\frac{2}{\rho} \cdot P_A} \Rightarrow \mathbf{3} \quad V = C \times \sqrt{P} \quad \text{where } C = \sqrt{\frac{2}{\rho}}$$

When we define a new constant, k , to include the value of the nozzle orifice outlet area (A), then we come to the following equation which says that for a nozzle spraying into a room at ambient pressure, the exiting flow is proportional to the feed line pressure.

$$Q = A \times V \Rightarrow Q = A \times C \times \sqrt{P} \Rightarrow \mathbf{4} \quad Q = K \times \sqrt{P}$$

$$\text{Where } K = A \times C \Rightarrow K = \sqrt{\frac{2 \cdot A^2}{\rho}}$$

Considering now two different pressure values for the same nozzle, since k is a constant quantity, we can write that:

$$K = \frac{Q}{\sqrt{P}} \Rightarrow K = \frac{Q_1}{\sqrt{P_1}} = \frac{Q_2}{\sqrt{P_2}} \Rightarrow \frac{Q_1}{Q_2} = \sqrt{\frac{P_1}{P_2}}$$

and derive from the above an equation that makes it possible to calculate the nozzle flow value at any given pressure value, once the flow value at another pressure value is known:

$$\mathbf{5} \quad Q_2 = Q_1 \times \sqrt{\frac{P_2}{P_1}}$$

NOZZLE FLOW RATE

The Equation (5) has been obtained after having simplified the real problem, neglecting several factors like for example:

- In most of the practical application cases the flow is turbulent and not laminar.
- Friction losses tend to strongly increase with liquid velocity.
- Depending upon the type of nozzle, a different percentage of the available energy is used to break up the jet and give the desired spray pattern and spray angle.

For the above reason equation (5) gives reliable results if used in a limited pressure range around the pressure value where the flow rate is known, with this pressure range depending upon the type of nozzle.

Our experience as shown that one can expect the error in the calculated value to be lower than +/- 6% for pressure values ranging from 1/3 to 3 times the reference value.

As an example, a nozzle rated for 10 lpm at 3 bars would have, according to equation (5) the following flow values:

a 1 bar 5,77 lpm

a 9 bar 17,3 lpm

in real conditions it can be expected the flow rate values, to be:

as high as 6,1 lpm a 1 bar

as low as 16,2 lpm a 9 bar

Above considerations are to be used as a guideline only, because of the many factors influencing real operations which have not been considered here, for example liquid, temperature, viscosity and density.

POSSIBLE PERCENTAGE DEVIATION FROM -THEORETICAL FLOW RATE VALUES.

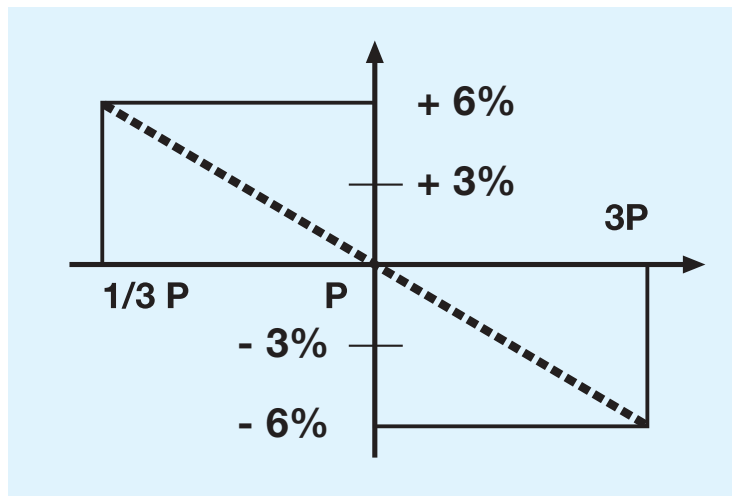

Also, above mentioned percentage errors have to be understood for nozzles using part of the flow energy to produce wide angle spray patterns.

Lower values can be expected for narrow angle nozzles, impact nozzles, and straight jet nozzles.

Laboratory tests and diagrams showing real flow rate values for each nozzles are used in practice when a precise result must be reached.

NOZZLE DISCHARGE COEFFICIENT

With reference to equation (4), if we consider the pressure value to be equal to 1, ($P = 1$ bar), the flow rate of the nozzle becomes.

$$Q = K \times \sqrt{\frac{P}{1}} \Rightarrow \boxed{K = Q} \quad K = \text{Nozzle capacity at 1 bar}$$

In some instances reference is made to the nozzle discharge coefficient or shortly to the nozzle coefficient to indicate the nozzle flow rate for a unitary pressure.

Of course, for a given pressure value P_n the flow value will be

$$Q_N = K \sqrt{P_n}$$

SPRAY ANGLE

The spray angle is the opening angle which the nozzle jet of droplets forms at the moment when it leaves the nozzle orifice, and it is one of the fundamental parameters for the choice of a given nozzle.

In fact the amplitude of the spray angle determines, in connection with the distance between the nozzle orifice and the target to be covered, the spray coverage and the density of liquid sprayed with respect to the cover area. See our Catalogue for description of the different nozzle spray patterns.

The table at the bottom of the page gives the theoretical spray width, based on the nozzle spray angle and the distance from the nozzle orifice.

It is important to note that, because of several factors like gravity forces and aerodynamic drag, the spray angle value cannot be maintained but in a limited distance, normally for 300 mm from the orifice.

For air assisted atomizers it is important to use the term spray angle, since no precise value can be measured. Therefore the values given by Catalogues are to be intended as guidelines only.

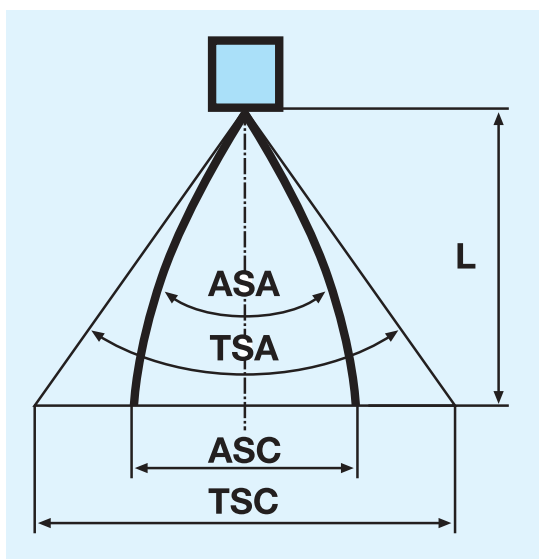

Where:

- **ASC** = Actual Spray Coverage
- **TSC** = Theoretical Spray Coverage
- **ASA** = Actual Spray Angle
- **TSA** = Theoretical Spray Angle
- **L** = Spray Distances

THEORETICAL SPRAY COVERAGE at various Distances (in mm) from Nozzle Orifice

Spray Angle	50 mm	100 mm	150 mm	200 mm	250 mm	300 mm	400 mm	500 mm	600 mm	700 mm	800 mm	1000 mm
15°	13	26	40	53	66	79	105	132	158	184	211	263
25°	22	44	67	89	111	133	177	222	266	310	355	443
30°	27	54	80	107	134	161	214	268	322	375	429	536
35°	32	63	95	126	158	189	252	315	378	441	505	631
40°	36	73	109	146	182	218	291	364	437	510	582	728
45°	41	83	124	166	207	249	331	414	497	580	663	828
50°	47	93	140	187	233	280	373	466	560	653	746	933
60°	58	116	173	231	289	346	462	577	693	808	924	1150
65°	64	127	191	255	319	382	510	637	765	892	1020	1270
70°	70	140	210	280	350	420	560	700	840	980	1120	1400
75°	77	154	230	307	384	460	614	767	921	1070	1230	1530
80°	84	168	252	336	420	504	671	839	1010	1180	1340	1680
90°	100	200	300	400	500	600	800	1000	1200	1400	1600	2000
95°	109	218	327	437	546	655	873	1090	1310	1530	1750	2180
100°	119	238	358	477	596	715	953	1190	1430	1670	1910	2380
110°	143	286	429	571	714	857	1140	1430	1710	2000	2290	-
120°	173	346	520	693	866	1040	1390	1730	2080	2430	-	-
130°	215	429	643	858	1070	1290	1720	2150	2570	-	-	-

INFLUENCE OF PRESSURE ON SPRAY ANGLE

Depending upon the nozzle design variations of feed pressure may have a great influence on the spray angle value. Generally with increasing pressure turbulence full cone nozzles will produce narrower angles, flat jet nozzles will show a wider angle spray, while nozzles working on the deflection principle like spiral nozzles and K style flat jet nozzles will be less affected by pressure changes.

All nozzles will not function properly with very low pressure values (from 0.5 bar down depending upon nozzle type) with a marked decay in performance, larger drops, not well defined spray pattern, lower spray angle values.

The above pictures show spray angles for different nozzles and different pressure values.

Should your application strictly require that a given value of the spray angle is obtained under a given pressure value or pressure range of values, please obtain a test report from our laboratories.

Full cone nozzle
DDW 2235



Pressure 0,5 bar

Flat jet nozzle
JCW 2245

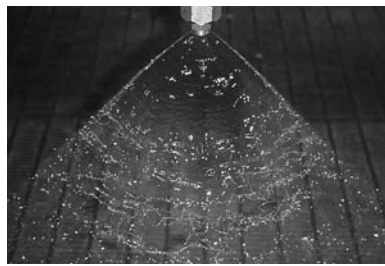

Pressure 0,5 bar

Spiral nozzle
ECW 2230



Pressure 0,5 bar



Pressure 3 bar

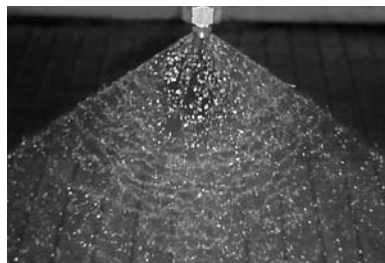

Pressure 3 bar



Pressure 3 bar



Pressure 10 bar



Pressure 10 bar



Pressure 10 bar

Photos obtained with 1/20.000s flashlight

VISCOSITY

Liquids are characterized for their property of undergoing continuous deformation when subjected to shear stress. The property of fluids (liquids or gases) to resist flowing due to the existence of internal friction within the fluid is called viscosity.

Thus, if we imagine the different layers of fluid sliding one over the other with friction, we can imagine that viscosity is defined the force required to move a unit area of fluid for a unit distance. Viscosity is measured with many different systems, among which the most used are the following:

		UNIT	DIMENSIONS	NOTES
1	Dynamic viscosity (Absolute viscosity)	Poise	$\frac{ML}{T}$	Poise = 100 Centipoises = (1 dyne per sec/cm ²)
2	Kinematic viscosity	Stoke	L ² / T	1 Stoke = 100 Centistoke = (cm ² /sec) Kinematic viscosity = Dynamic viscosity/density
3	SSU/SSF	One of the most widely instruments to determine is the Saybolt viscosimeter, which measures the time in seconds required for a fixed volume of a given liquid to flow through an orifice. SSU = Seconds Saybolt Universal relates to a smaller orifice for less viscous liquids. SSF = Seconds Saybolt Furol relates to a larger orifice for more viscous liquids.		

The following table shows correspondences between the most used viscosity units.

KINEMATIC VISCOSITY		SAYBOLT UNIVERSAL	SAYBOLT FUROL	ENGLER
Centistoke	Sq feet/sec	SSU	SSF	Degrees
1,00	0,0001076	31,0	---	1,00
5,00	0,0005382	42,4	---	1,37
10,00	0,001076	58,8	---	1,83
15,66	0,001686	80	---	2,45
20,52	0,002209	100	---	3,02
25,15	0,002707	120	---	3,57
42,95	0,004623	200	---	5,92
108,0	0,001163	500	52,3	14,60
151,0	0,001625	700	72,0	20,44
194,2	0,002090	900	92,1	26,28
302,3	0,003254	1400	143	40,90
388,5	0,004182	1800	183	52,60
539,4	0,005806	2500	254	73,00
1078,8	0,01161	5000	509	146
1510,3	0,01626	7000	712	204
1941,9	0,02092	9000	916	263
3236,5	0,03483	15000	1526	438

The viscosity value of a liquid depends upon the temperature, therefore the viscosity value must always be given with reference to a temperature value.

The viscosity of water (20° C) is 1 Centipoise and 1 Centistoke, since water mass density = 1.

VISCOSITY INFLUENCE ON NOZZLE FLOW RATE

All nozzle Catalogue data refer to spraying water (water cinematic viscosity is equal to 1 Centistoke).

A liquid with viscosity higher than water will require more energy to be pumped and sprayed and will flow with lower velocity at the same pressure, and this will cause a reduction in the turbulence of the flow.

For the above reason, nozzles working on the turbulence principle, like normal full cone nozzles and whirl hollow cone nozzles, will show an increase in capacity while spraying liquids with viscosity higher than water.

This increase is very consistent for small size nozzles, where the small radius of the whirl chamber tends to cause high turbulence in the flow, and tends to diminish and to disappear for nominal capacity (capacity at 3 bars) values larger than 1,5 liters per minute.

The graph below shows, for a liquid with a viscosity of about 4 Centistokes, typical variations in the nozzle flow rate value, for different values of the nozzle whirl chamber diameter.

As it may be seen, these variations can be neglected in most practical applications, where nozzles with whirl chamber diameters well over 3 mm are used.

Increase Flow rate vs Whirl Chamber Diameter

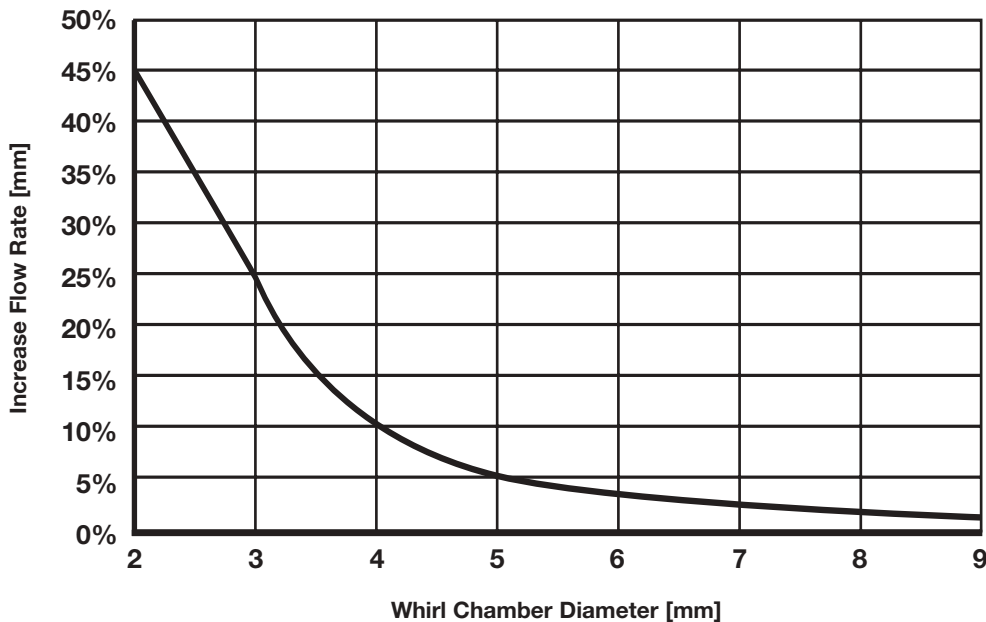

For other types of nozzles, not working on the turbulence principle, the increase on viscosity will simply reduce the liquid exit velocity at the orifice, thus causing a decrease in capacity.

Experience shows that this decrease ranges between 3 and 6% of nominal water capacity, that is to say that the variation introduced is in the same order of magnitude as the nozzle flow rate tolerance.

VISCOSITY INFLUENCE ON NOZZLE SPRAY ANGLE AND SPRAY PATTERN

With reference to the theory of jet break-up and droplet information it can be easily imagined that spraying a liquid more viscous than water is a difficult task.

All the properties of the spray tend to worsen, therefore one can expect

1. A higher value for the minimum operating pressure, that is the pressure value which allows for obtaining a well defined spray with the expected spray angle.
2. A worse spray distribution, since the viscous behavior of the liquid makes it more difficult to produce fine droplets and to distribute them evenly with the desired spray pattern.
3. A narrower spray angle.

It is difficult to give guidelines, since results on different nozzles, at different pressures and with different liquids are scarcely predictable.

However, our experience shows that in many cases the use of impact nozzles can give acceptable results, where other type of nozzle fail.

A laboratory test, or a field test are still the safest way to obtain sound results.

SPECIFIC GRAVITY

With reference to the Bernoulli Rule, as exposed in page 10, one can say that the pressure energy of the liquid flow at the nozzle inlet is transformed totally (minus some losses due to friction inside the nozzle) into liquid velocity at the nozzle orifice.

Catalogue figures give nozzle capacities when spraying water.

If the specific gravity or density of the liquid is different from that of water the available pressure energy will produce a different liquid velocity at the nozzle orifices.

In other words a given quantity of energy will spray always the same quantity of liquid mass, but different volumes (flow rates) according to the liquid specific gravity or density.

Therefore a liquid heavier than water will exit the nozzle with a lower velocity, at lower flow rate, while to the contrary a liquid lighter than water will be sprayed at higher velocity, at higher flow rate.

The following formula is to be applied:

$$Q_L = F \times Q_W$$

Where:

Q_L Liquid flow rate

Q_W Water flow rate

F Correction factor

The table below gives the value of a correction factor to obtain the flow rate of a liquid with different specific weight as water.

kg/liter	Lbs/gallon	F
0,6	5,0	1,29
0,7	5,8	1,20
0,8	6,7	1,12
0,9	7,5	1,05
1,0	8,3	1,00
1,1	9,2	0,95
1,2	10,0	0,91
1,3	10,9	0,88
1,4	11,7	0,85
1,5	12,5	0,82
1,6	13,4	0,79
1,7	14,2	0,77
1,8	15,0	0,75
1,9	15,9	0,73
2,0	16,7	0,71

IMPACT OF WATER JET

The spraying water impact of a nozzle depends on several factors and more precisely spray distribution pattern and spray angle. The first step to calculate the impact value, which is usually expressed in Kilograms per square centimeter, is to determine **Total Theoretical Impact** Value using the following formula:

$$TTI = 0,024 \times Q \times \sqrt{P} \quad [\text{kgf/cm}^2]$$

Where:
 Q is the flow rate at working pressure in lpm
 P is the pressure value in kgf/cm²

The obtained value has to be multiplied by the **Total Theoretical Impact per Square Centimeter Coefficient (E)**. The final value is the **Spraying Liquid Impact** expressed in kgf/cm². Of course not all the energy of the fluid vein is transferred to the impact point.

$$SLI = E \times TTI \quad [\text{kgf/cm}^2]$$

A part of this energy, sometimes a considerable part, goes to obtain a desired spraying angle by having the liquid vein acquire a high rotational speed inside the whirl chamber. The highest value of impact is obtained with straight jet nozzle and the value can be calculated multiplying spraying pressure per 1,9. The tables below containing the Total Theoretical Impact sqcm coefficient values for different spray pattern nozzles for a distance of 300 mm.

TOTAL THEORETICAL IMPACT PER SQ CM COEFFICIENT AT DISTANCE OF 300 mm (E)					
Spray Angle	Flat jet nozzle	Spray Angle	Full cone nozzle	Spray Angle	Hollow cone nozzle
15°	0,300	15°	0,110		
25°	0,180				
35°	0,130	30°	0,025		
40°	0,120				
50°	0,100	50°	0,010		
65°	0,070	65°	0,004		
				60°/80°	0,01/0,02
80°	0,050	80°	0,002		
		100°	0,001		

NOZZLE MATERIALS

The choice of the right material for a nozzle is sometimes the most important one to do, since the nozzle operating life depends upon it.

There are several factors to influence or shorten the nozzle operating life, sometimes more than one at the same time, the most important being:

1. Wear from solid particles suspended into the liquid being sprayed.
2. Chemical corrosion from the liquid being sprayed.
3. Chemical corrosion from the ambience outside the nozzle
4. Exposure to high temperature.
5. Exposure to mechanical shocks.

NOZZLE MATERIALS

PNR material code	19
Typical nozzle materials	20
Material mechanical properties	24
Material chemical resistance	25

PNR MATERIAL CODES

PNR has adopted a short coding to indicate construction materials, which will be used in the following tables. While the complete list is given at the end of this chapter, we report here the material codes used in the chemical resistance tables.

A1	Free Cutting Steel
A2	Carbon Steel
A8	Zinc Plated Mild Steel
A9	Nickel Plated Mild Steel
B2	AISI 304 Stainless Steel
B3	AISI 316 Stainless Steel
B31	AISI 316L Stainless Steel
B4	AISI 321 Stainless Steel
B8	AISI 309 Stainless Steel
B81	AISI 310 Stainless Steel
C1	AISI 420 Hardened
C4	AISI 317 Stainless Steel
C6	SAF 2205 Stainless Steel
D1	Polyvinylchloride (PVC)
D2	Polypropylene (PP)
D3	Polyamide (PA)
D5	Powder Charged PP
D6	Fiberglass Charged PP
D7	High Density Polyethylene
D8	Polyvinylidene fluoride (PVDF)

E1	TEFLON® (PTFE)
E3	DELTRIN®
E6	PERSPEX® (PMMA)
E7	VITON®
E8	NBR- Sh 70 Rubber
E81	SANTOPRENE® Rubber
E82	KLINGERITE®
E83	HYPALON®
E91	Silicon
F1	Tungsten Carbide (TC)
F2	PIREX®
F3	Ruby
F4	Sapphire
F5	Ceramic
F6	Silicon Carbide (SC)
G1	Cast Iron
H1	Titanium
L1	MONEL 400
L2	INCOLOY® 825
L21	INCONEL® 600

L3	NICROFER® 5923
L4	STELLITE® 6
L5	HASTELLOY® B2
L6	HASTELLOY® C4
L61	HASTELLOY® C22
L62	ULTIMET®
L7	NICKEL 201
L8	HASTELLOY® C276
L9	SANICRO® 28 SS
N1	AISI 302 Stainless Steel
P6	ABS
P7	FASIT OIL
P8	EPDM ShA Rubber
P9	STIROLUX® 637
T1	Brass
T3	Copper
T5	Bronze
T8	Nickel Plated Brass
V1	Aluminium
V7	Aluminium ENP

MATERIAL STANDARDS

The following standards are mentioned with reference to materials identification

STANDARD ORGANIZATION		COUNTRY	STANDARD CODE
AFNOR	Association Française de Normalisation	France	NF
AISI	American Iron and Steel Institute	USA	AISI
ANSI	American National Standards Institute	USA	ANSI
ASTM	American Society for Testing and Materials	USA	ASTM
BSI	British Standards Institution	UK	BS
DIN	Deutsches Institut für Normung	Germany	DIN
DS/IT	Dansk Standards/Information Technology	Denmark	DS
ISO	International Organization for Standardization	International	ISO
JIS	Japanese Institute for Standard	Japan	JIS
UNI	Ente Nazionale di Unificazione	Italy	UNI

B1 AISI 303 STAINLESS STEEL			
CHEMICAL COMPOSITION	CR 17,50 NI 8.50 S 0,25	CODING CORRESPONDENCE	
Type	Stainless Steel Austenitic	AISI	303
Hardening	Not possible	BS	303 S 21
Annealing	1050 /1100° C in water	DIN Wnr	1.4305
Welding	Possible with precautions	Euro	X10CrNiS18.09
Corrosion properties	Good resistance: Atmospheric exposure, food substances, organic chemicals. Low resistance: Chlorides, reducing acids and over 800° C	JIS	SUS 303
		NF	Z6CN 18-09
		SIS	2346
		UNI	XWCrNiS 1809

B3 AISI 316 STAINLESS STEEL			
CHEMICAL COMPOSITION	C 0,05 CR 17,0 NI 12,0 MO 2,25	CODING CORRESPONDENCE	
Type	Stainless Steel Austenitic	AISI	316
Hardening	Not possible	BS	316 S 21
Annealing	1050 /1100° C in water	DIN Wnr	1.4401
Welding	Easy, using same steel electrodes	Euro	X6CrNiMo17122
Corrosion properties	Good resistance: Atmosphere, great number of salts, organic acids, foods, salt water Low resistance: Solutions of reducing acids temperatures over 500° C	JIS	SUS 316
		NF	Z6CND 17-11
		SIS	2347
		UNI	X5CrNiMo1712

B31 AISI 316L STAINLESS STEEL			
CHEMICAL COMPOSITION	C 0,03 CR 17,0 NI 13,0 MO 2,25	CODING CORRESPONDENCE	
Type	Stainless Steel Austenitic	AISI	316 L
Hardening	Not possible	BS	316S12
Annealing	1050 /1100° C in water	DIN Wnr	1.4404
Welding	Easy, using same steel electrodes	Euro	X3CrNiMo1810
Corrosion properties	Good resistance: Atmosphere, great number of salts, organic acids, foods, salt water Low resistance: Solutions of reducing acids temperatures over 500° C	JIS	SUS 316L
		NF	Z2CND17-12
		SIS	2348
		UNI	X2CrNiMo 1712

C1 AISI 420 STAINLESS STEEL (TEMPERED)

CHEMICAL COMPOSITION	C 0,20 CR 13,00	CODING CORRESPONDENCE	
Type	Stainless Steel Martensitic	AISI	420
Hardening	980° - 1030° C in oil	BS	420 S 29
Annealing	750° - 800° C in air.	DIN Wnr	1.4021
Welding	Possible with precautions	Euro	X20Cr13
Corrosion properties	Good resistance Drinkable water, steam, gasoline, oil, alcohol, ammonia.	JIS	SUS 420 J1
		NF	Z20C13
		SIS	2303
		UNI	X20Cr13

C2 AISI 416 STAINLESS STEEL (TEMPERED)

CHEMICAL COMPOSITION	C 0,12 CR 12,50 S 0,22	CODING CORRESPONDENCE	
Type	Stainless Steel Martensitic	AISI	416
Hardening	950 - 1100° C in oil	BS	416 S 21
Annealing	750 - 800° C.	DIN Wnr	-
Welding	Not possible	Euro	X12CrS13
Corrosion properties	Good resistance Drinkable water, steam, gasoline, oil, alcohol, ammonia.	JIS	SUS 416
		NF	Z12CF13
		SIS	-
		UNI	X12CrS13

E31 ACETAL (ACETAL HOMOPOLYMERS AND COPOLYMERS)

DESCRIPTION	HIGHLY CRYSTALLINE RESINS BASED ON FORMALDEHYDE POLYMERIZATION TECHNOLOGY	
Trade names & Suppliers	DELRIN	(Dupont, Polymer Products Corporation)
	CELCON	(Hoechst Celanese Corporation)
	ULTRAFORM	(BASF Corporation)
	RTP 800	(RTP CORPORATION)
	LUPITAL & TENAL	(Franklin Polymers, Inc)
	FULTRON 404	(ICI Americas, Inc)
Physical and Mechanical Properties	High tensile strength, rigidity and resilience.	
	High fatigue endurance.	
	Excellent dimensional stability	
	Low coefficient of friction	
	Outstanding abrasion and wear resistance	
Thermal Properties	Excellent creep resistance.	
	Heat deflection temperatures range from 110 -136° C at 18,2 bars (230 - 270° F at 264 psi), higher if glass filled.	
Chemical Compatibility	Remains stable in long-term, high temperature water immersion. Excellent resistance to chemicals and solvents, but prolonged exposure to strong acids not recommended. Note: Suitable for close-tolerance high-performance parts. Available for machined parts, or may be injection molded.	

D8 POLYVINYLIDENE FLUORIDE (PVDF)	
DESCRIPTION	HIGH-MOLECULAR WEIGHT, THE TOUGHEST OF THE FLUOROCARBON RESINS
Trade names & Suppliers	KYNAR (Atochem North America Inc formerly Penwalt Corporation)
	SOLEF (Solvay Polymer Corporation).
Physical and Mechanical Properties	Excellent resistance to abrasion and stress fatigue
	Extremely pure, opaque white resin.
Thermal Properties	Useful in temperatures ranging from -73 / 149°C (-100 / 300°F). Heat deflection temperature is (80/90° C at 18,2 Bars (176 / 194° F at 264 psi).
Chemical Compatibility	Excellent chemical resistance. Can be used with wet or dry halogens, most strong acids and bases, aliphatics, aromatics, alcohols and strong oxidizing agents. Not recommended for contact with ketones, esters, amines and some organic acids (fuming sulfuric acid).

E1 POLYTETRAFLUOROETHYLENE (PTFE)	
DESCRIPTION	FLUOROPLASTIC THAT HAVE SOME OR ALL OF THEIR HYDROGEN MOLECULES REPLACED BY FLUORINE
Trade names & Suppliers	TEFLON TFE, FEP and PFA (Dupont, Polymer Products)
	NEOFLON (Daikin)
	FLUON (ICI Americas, Inc.)
	SST-2/SST-3 (Shamrock Technologies, Inc)
Physical and Mechanical Properties	Low coefficient.
	Low adhesiveness.
	Good weatherability.
	Low resistance to creep and wear, unless reinforced with glass fibers, which results in superior resistance.
Thermal Properties	High and low temperature stability. Heat deflection temperatures range from 48/55° C at 18,2 bar (118-132° F at 264 psi).
Chemical Compatibility	Chemically inert.
	Totally insoluble.

L6 HASTELLOY C 4		
PHYSICAL AND MECHANICAL PROPERTIES	CHEMICAL COMPOSITION	CORROSION RESISTANCE
R = 650/800 Mpa	C = 0.015 max	Very good against pitting and tensile corrosion, specially in oxydizing atmosphere. Resistance in welded joints definitely better than C 276, lower than C22
Rp _{0.2} = 250/470 Mpa	Ni = 65	
HRB = 90	Cr = 16.0	
	Mo = 15.5	
	W = --	
	Fe = 3 max	
	Ti = 0.5	
	Co = 2 max	
APPLICATIONS Recommended for applications with strongly oxidizing atmosphere.		

L61 HASTELLOY C 22		
PHYSICAL AND MECHANICAL PROPERTIES	CHEMICAL COMPOSITION	CORROSION RESISTANCE
R = 700/800 Mpa	C = 0.01 max	Excellent performances with oxydizing atmospheres as well as for pitting and tensile corrosion conditions. Very good resistance in reducing atmospheres and for welded joints.
Rp _{0.2} = 360/420 Mpa	Ni = 56	
HRB = 93	Cr = 22	
Mo	= 13	
W	= 3	
Fe	= 3	
Ti	= --	
Co	= 2.5 max	
APPLICATIONS Chemical industry (gas ducts, gas washing and treatment systems, phosphoric acid production) Heat exchangers, pumps, chlorination reactors.		

L8 HASTELLOY C 276		
PHYSICAL AND MECHANICAL PROPERTIES	CHEMICAL COMPOSITION	CORROSION RESISTANCE
R = 600/800 Mpa	C = 0.015 max	Very good in reducing and oxydizing atmospheres. Very good against pitting and tensile corrosion. Acceptable resistance in welded joints. In cast parts excessive segregation, not eliminated by thermal treatment of annealing, makes it convenient to use C22 or C4 qualities which assure better corrosion resistance and mechanical properties.
Rp _{0.2} = 300/370 Mpa	Ni = 57	
HRB = 90	Cr = 14.5/16.5	
	Mo = 15/17	
	W = 3/4.5	
	Fe = 4/7	
	V = 0.35 max	
	Co = 2.5 max	
APPLICATIONS Chemical industry (air ducts, scrubbers, fans) Paper industry Thermoelectric plants Steel thermal treatments		

MECHANICAL PROPERTIES

MATERIAL	TENSILE STRESS RESISTANCE [MPa]				CORROSION RESISTANCE
	Rp 0,2		R		
	20° C	800° C	20° C	800° C	
	(68° F)	(1408° F)	(68° F)	(1408° F)	
AISI 302	280	100	680	200	Good: sensitive to corrosion between grains for slow heating and cooling in the 450-900° C range temperature.
AISI 303	280	100	680	200	Discrete.
AISI 304/304L	270	90	600	100	Good, especially for 304L. 304 sensitive to corrosion between grains like AISI 302.
AISI 309	250	100	640	220	Good. Sensitive to corrosion between grains like AISI 302.
AISI 310	310	170	650	270	Good. (> 304 - 304L). sensitive to corrosion between grains like AISI 302.
AISI 316/316L	270	110	560	220	Very high, especially for 316L.
AISI 321	210	100	540	140	Good.
AISI 347	280	120	620	200	Good.
AISI 416	620	70	750	90	Good in medium corrosive ambient (atmosphere, water gasoline, alcohol, N1-13, foods). Not in high corrosive.
BRASS	110-150	-	360-410	-	Good, especially when nickel plated
BRONZE	100-300	-	200-600	-	Discrete, especially with sea water.
CAST IRON	≤ 500	V	100-800	V	
NICKEL ALLOYS	100-1000	V	300-1300	V	Very high also for high temperature. To use in the temperature range 800-1200° C.
PLASTICS	-	-	20-200	-	Good, also for erosion. Generally they are attacked with oxidizers like nitric acid, halogens, ect.
PTFE	-	-	30-40	-	Very high, except for elementary state of alkaline metals and to compounds containing fluorine at high temp.
DUPLEX STEEL	>AISI 3..	>AISI 3..	>AISI 3..	>AISI 3..	Very high, also with high temperature and also for pitting.
TITANIUM alloy	195-850	V	300-900	V	Very high in oxidizing ambient. Very low in reducing ambient and with compounds containing fluorine.

Legend: **Rp 0,2** = YIELD POINT **R** = ULTIMATE TENSILE STRESS **V** = To verify time by time

MATERIAL CHEMICAL RESISTANCE

RATING CHEMICAL BEHAVIOR
A No effect
B Minor effect
C Moderate effect
D Severe effect, not recommended
- No data available

TABLE 1	PLASTICS						ELASTOMERS				METALS								NO METALS			
	ABS Plastic	Acetal (DELTRIN)	Polypropylene (PP)	PTFE (TEFLON)	PVC	PVDF (KYNAR)	Buna N	EPDM	Natural Rubber	VITON	AISI 304 S.S.	AISI 316 S.S.	Aluminium	Brass	Bronze	Cast Iron	Copper	Hastelloy C	Titanium	Carbon Graphite	Ceramic Al ₂ O ₃	Ceramic Magnet
Acetaldehyde	D	B	A	A	D	D	D	A	C	A	A	A	B	A	A	C	-	A	A	A	-	-
Acetamide	-	A	A	A	D	D	A	A	D	B	B	A	A	-	D	D	A	A	A	A	-	-
Acetate Solvent	-	-	B	A	D	A	C	A	C	D	A	A	A	A	C	D	A	A	A	A	-	-
Acetic Acid	D	D	B	A	D	C	B	A	B	D	D	A	B	D	C	D	B	A	A	A	A	-
Acetic Acid 20	C	C	A	A	D	A	B	A	B	B	B	A	B	D	C	D	B	A	A	A	A	A
Acetic Acid 80	D	D	A	A	C	C	C	A	C	B	D	B	B	D	C	D	B	A	A	A	A	A
Acetic Acid, Glacial	D	D	A	A	D	A	C	-	C	D	C	A	B	-	C	D	B	A	A	A	A	A
Acetic Anhydride	C	D	B	A	D	B	B	B	C	D	B	B	A	D	C	D	B	A	A	A	A	-
Acetone	D	A	A	A	D	D	D	A	C	D	A	A	A	B	A	A	A	A	A	A	A	-
Acetyl Bromide	-	-	-	A	D	-	-	-	-	-	-	-	-	-	-	-	-	-	-	-	-	-
Acetyl Chloride (dry)	D	D	D	A	C	A	D	D	D	A	A	A	D	D	-	B	A	A	-	-	-	-
Acetylene	-	A	A	A	A	A	B	A	B	A	A	A	A	C	C	A	D	-	-	A	-	-
Acrylonitrile	D	-	A	A	B	A	D	D	B	D	A	A	B	A	-	A	A	B	-	B	-	-
Adipic Acid	-	-	B	A	A	-	C	A	A	A	A	A	A	-	-	A	D	-	-	A	-	-
Alcohols Amyl	-	A	B	A	A	A	A	A	B	A	A	A	B	A	A	B	A	A	B	A	A	-
Alcohols Benzyl	D	A	A	A	D	A	D	B	D	A	B	B	B	-	A	B	B	A	A	-	A	-
Alcohols Butyl	A	A	A	A	A	A	A	B	A	A	A	A	B	A	A	B	A	A	A	A	A	-
Alcohols Diacetone	-	A	B	A	B	A	D	A	D	D	A	A	A	A	A	A	-	A	A	A	-	-
Alcohols Ethyl	B	A	A	A	C	-	C	A	-	A	A	A	B	A	A	B	A	A	A	A	A	-
Alcohols Exyl	-	A	-	A	A	-	A	C	A	C	A	A	A	-	A	A	A	A	A	-	-	-
Alcohols Isobutyl	B	A	A	A	A	-	B	A	A	A	A	A	B	-	A	C	A	A	B	A	-	-
Alcohols Isopropyl	-	A	A	A	A	-	A	A	A	A	B	B	B	-	A	A	B	A	B	A	A	A
Alcohols Metyl	D	A	B	A	A	A	A	A	A	D	A	A	A	A	A	A	A	A	B	A	A	A
Alcohols Octyl	A	A	-	-	-	-	B	A	B	B	A	A	A	-	A	A	A	C	A	-	-	-
Alcohols Propyl	B	A	A	A	A	A	A	A	A	A	A	A	A	A	A	A	A	A	A	-	-	-
Aluminum Chloride	A	-	A	A	A	A	A	A	A	A	B	B	D	D	D	D	B	A	B	-	-	-
Aluminum Chloride 20	-	C	A	A	A	A	A	A	A	A	D	C	D	D	D	D	-	A	B	-	-	-
Aluminum Floride	A	C	A	A	A	A	A	A	B	A	D	D	B	-	-	D	D	B	A	-	-	-
Aluminum Hydroxide	B	A	A	A	A	A	A	A	D	A	A	C	B	B	C	A	D	B	B	A	-	-
Aluminum Nitrate	-	B	A	A	B	A	A	A	A	A	A	A	D	-	-	-	-	-	A	-	-	-
Aluminum Potassium Sulfate 10	-	C	A	A	A	B	A	A	A	A	A	A	C	A	-	D	A	C	A	A	-	-
Aluminum Potassium Sulfate 100	-	C	A	A	A	-	A	A	A	A	D	B	C	-	-	D	B	C	A	A	-	-
Aluminum Sulfate	A	B	A	A	A	A	A	A	A	A	B	B	B	B	B	D	A	B	A	A	A	-
Alums	-	A	A	A	-	-	A	A	A	A	-	B	A	B	-	D	C	B	A	-	-	-
Amines	-	D	B	A	D	-	D	B	B	D	A	A	B	B	D	D	-	B	B	A	-	-
Ammonia 10	-	D	A	A	B	A	A	A	D	D	A	A	A	-	D	A	-	A	C	A	A	-
Ammonia, anhydrous	D	D	A	A	A	A	B	A	D	D	A	A	A	D	D	A	D	B	C	A	A	-
Ammonia, liquid	-	D	A	A	A	A	B	A	D	D	B	A	A	D	D	A	-	B	C	A	A	-
Ammonium Acetate	-	-	A	A	A	-	B	A	-	A	B	A	A	D	D	-	-	-	-	-	-	-
Ammonium Bifluoride	A	D	A	A	A	A	B	A	-	A	D	B	B	-	D	D	-	B	-	-	-	-
Ammonium Carbonate	A	D	A	A	A	A	B	A	A	C	B	B	B	D	D	-	-	-	-	-	-	-
Ammonium Caseinate	-	D	-	-	-	-	-	-	-	-	-	A	-	-	-	-	-	-	-	A	A	A
Ammonium Chloride	A	B	A	A	A	A	B	A	A	A	C	B	B	D	D	D	D	D	B	A	A	A
Ammonium Hydroxide	B	C	A	A	A	A	D	A	D	B	A	A	B	D	D	D	D	B	A	A	A	A

RATING CHEMICAL BEHAVIOR

- A** No effect
- B** Minor effect
- C** Moderate effect
- D** Severe effect, not recommended
- No data available

TABLE 2	PLASTICS						ELASTOMERS				METALS								NO METALS			
	ABS Plastic	Acetal (DELRIN)	Polypropylene (PP)	PTFE (TEFLON)	PVC	PVDF (KYNAR)	Buna N	EPDM	Natural Rubber	VITON	AISI 304 S.S.	AISI 316 S.S.	Aluminium	Brass	Bronze	Cast Iron	Copper	Hastelloy C	Titanium	Carbon Graphite	Ceramic Al ₂ O ₃	Ceramic Magnet
Ammonium Nitrate	-	A	A	A	A	A	A	A	C	A	A	A	B	D	D	B	D	B	A	A	A	-
Ammonium Oxalate	-	B	A	-	A	-	D	A	-	-	A	A	-	-	D	D	C	A	-	-	-	-
Ammonium Persulfate	A	D	A	A	A	A	A	B	A	A	A	B	D	D	D	D	D	B	A	A	A	A
Ammonium Phosphate, dibasic	A	B	A	A	A	A	A	A	A	A	B	C	B	B	D	D	D	B	A	A	-	-
Ammonium Phosphate, monobasic	-	B	A	A	-	A	A	A	A	A	B	C	B	-	D	D	D	B	A	-	-	-
Ammonium Phosphate, tribasic	-	B	A	A	-	A	A	A	A	A	B	B	B	-	C	D	D	B	A	A	A	A
Ammonium Sulfate	A	B	A	A	A	A	A	A	A	A				D	D	D	D	-	-	C	-	-
Ammonium Sulfite	-	D	A	A	A	-	A	A	A	D	B	B	D	-	A	D	D	-	A	D	-	-
Ammonium Thiosulfate	-	B	-	-	-	-	A	A	-	-	-	A	-	D	D	D	D	-	A	-	-	-
Amyl Acetate	D	B	B	A	D	A	D	A	D	D	A	A	A	A	A	C	A	A	A	A	A	-
Amyl Alcohol	A	A	B	A	D	A	B	A	B	D	A	A	B	A	A	B	A	A	B	A	A	-
Amyl Chloride	D	A	D	A	D	A	D	D	D	B	A	A	A	-	A	A	A	A	A	C	A	-
Aniline	D	A	A	A	C	A	D	B	D	C	A	B	C	D	C	C	D	B	C	-	-	-
Aniline Hydrochloride	D	-	D	A	B	A	D	B	A	A	D	D	D	D	D	D	B	D	A	D	-	-
Antifreeze	B	D	D	-	A	-	A	A	A	A	-	A	A	-	A	A	-	-	-	-	-	-
Antimony Trichloride	A	-	A	A	A	A	B	B	-	A	D	D	D	D	A	-	-	-	B	-	B	-
Aqua Regia (80% HCl, 20% HNO3)	D	D	B	A	C	A	D	C	D	B	D	D	D	D	D	D	D	-	-	D	-	C
Arochlor 1248	-	-	D	A	D	-	C	B	D	A	B	B	A	A	A	B	-	A	A	-	-	-
Aromatic Hydrocarbons	-	A	D	-	-	-	D	D	D	A	-	C	A	-	C	A	-	-	-	-	-	-
Arsenic Acid	A	D	A	A	A	A	A	A	B	A	A	B	D	D	B	D	A	B	B	A	-	-
Arsenic Salts	-	-	-	-	A	-	-	-	-	A	-	-	-	-	-	-	-	-	-	-	-	-
Asphalt	-	A	B	A	A	A	B	D	A	A	B	A	A	B	A	A	A	-	-	-	-	-
Banum Carbonate	A	A	A	A	A	A	A	A	-	A	B	B	D	B	B	A	A	B	A	-	-	-
Barium Chloride	A	A	A	A	A	A	A	A	A	A	A	B	D	B	B	C	B	B	A	A	A	A
Barium Cyanide	-	B	A	A	A	A	C	A	-	A	A	A	C	C	C	C	D	A	-	-	-	-
Barium Hydroxide	A	D	B	A	A	A	A	A	A	A	B	B	D	D	D	D	-	B	B	A	A	A
Barium Nitrate	-	B	A	A	A	-	A	A	-	A	B	B	B	D	D	A	B	-	A	A	-	-
Barium Sulfate	A	B	B	A	B	A	A	A	A	A	B	B	B	B	C	B	B	A	B	A	A	A
Barium Sulfide	A	A	B	A	A	A	A	A	A	A	B	B	D	D	D	D	D	-	A	A	A	A
Beer	A	A	B	A	A	A	A	A	A	A	A	A	A	B	A	D	B	A	B	A	-	A
Beet sugar liquids	B	B	A	A	A	A	A	A	A	A	A	A	A	-	C	A	A	-	A	A	-	A
Benzadehyde	B	A	D	A	D	A	D	A	D	D	B	B	B	-	A	A	B	A	A	A	A	A
Benzene	D	A	D	A	C	A	D	D	D	A	B	B	B	-	A	A	B	B	A	A	A	A
Benzene Sulfuric Acid	-	-	D	A	A	-	D	D	A	A	B	B	D	-	-	-	-	B	B	A	A	
Benzoic Acid	-	B	B	A	A	A	D	D	D	A	B	B	B	B	B	A	B	B	A	A	A	A
Benzol	D	A	-	A	-	-	D	D	D	A	-	B	-	A	-	D	-	-	-	-	-	-
Benzonitrile	-	-	-	A	-	-	-	-	-	-	D	D	-	-	-	-	-	C	-	A	-	-
Benzyl Chloride	D	A	C	-	-	-	D	D	D	A	C	B	D	-	D	-	D	C	-	A	-	-
Bleaching Liquors	-	-	A	-	-	-	D	A	D	A	-	-	-	-	-	-	-	-	A	-	-	-
Borax (Sodium Borate)	-	A	B	A	A	A	B	A	A	A	A	A	B	A	B	A	B	B	B	A	-	A
Boric Acid	-	A	A	A	A	A	A	A	A	A	B	A	D	B	B	D	B	A	A	A	A	A
Brewery Slop	-	B	-	-	-	-	A	-	-	A	-	A	-	-	A	-	-	-	-	-	-	-
Bromine	D	D	D	A	C	A	D	D	D	A	D	D	D	-	D	-	-	A	D	D	A	A
Butadiene	-	A	C	A	C	A	D	C	D	A	A	A	A	A	C	-	C	C	-	A	-	-

RATING CHEMICAL BEHAVIOR

- A** No effect
- B** Minor effect
- C** Moderate effect
- D** Severe effect, not recommended
- No data available

TABLE 3	PLASTICS						ELASTOMERS				METALS								NO METALS			
	ABS Plastic	Acetal (DEL RIN)	Polypropylene (PP)	PTFE (TEFLON)	PVC	PVDF (KYNAR)	Buna N	EPDM	Natural Rubber	VITON	AISI 304 S.S.	AISI 316 S.S.	Aluminium	Brass	Bronze	Cast Iron	Copper	Hastelloy C	Titanium	Carbon Graphite	Ceramic Al ₂ O ₃	Ceramic Magnet
Butane	B	A	A	A	C	A	A	D	D	A	A	A	A	C	-	C	A	A	A	-	-	
Butanol (Butyl alcohol)	-	A	A	A	C	A	A	A	A	A	A	A	B	-	A	-	B	B	B	A	-	-
Butter	B	A	-	A	-	-	A	A	D	A	C	A	A	-	D	D	-	-	-	A	-	-
Buttermilk	B	A	A	A	A	-	A	A	D	A	A	A	A	-	D	D	-	A	-	-	-	-
Butyl Amine	-	C	B	A	D	A	-	-	D	D	-	A	A	-	B	-	-	B	B	A	-	-
Butyl Ether	-	D	D	A	A	A	-	D	D	D	-	A	A	-	-	-	-	-	A	-	-	
Butyl Phthalate	-	-	B	A	-	B	D	B	D	C	B	B	B	-	-	-	-	B	B	A	-	-
Butylacetate	-	A	B	A	D	B	D	B	D	D	B	A	A	A	A	A	A	A	A	A	-	A
Butylenes	-	A	-	A	A	A	A	D	D	A	A	A	A	-	D	-	D	-	-	A	-	-
Butyric Acid	D	A	-	A	-	-	D	B	D	B	B	B	B	C	D	D	C	A	A	A	-	A
Calcium bisulfate	-	-	-	-	-	-	A	A	A	-	-	A	-	-	-	D	-	-	-	-	-	
Calcium Bisulfide	-	D	A	A	A	A	A	C	D	A	B	B	C	-	C	-	-	A	A	-	-	A
Calcium Bisulfite	-	D	A	A	A	B	A	D	D	A	B	A	D	B	-	-	-	B	A	A	-	A
Calcium Carbonate	-	A	A	A	A	A	A	A	A	A	A	B	D	-	A	-	-	B	B	A	A	-
Calcium chlorate	-	A	-	A	B	A	A	A	-	A	-	-	-	-	-	-	A	-	-	-	A	-
Calcium Chloride	B	D	A	A	C	A	A	A	A	A	C	C	D	D	A	C	B	A	A	A	A	A
Calcium Hydroxide	-	D	A	A	B	A	A	A	A	A	B	B	C	D	D	A	-	A	A	A	A	A
Calcium Hypochlorite	-	D	A	A	B	A	C	B	D	A	C	B	D	-	D	D	-	B	A	A	A	A
Calcium nitrate	-	D	A	A	A	A	A	A	A	A	C	B	B	-	B	B	-	B	B	A	A	-
Calcium Oxide	D	A	A	A	B	A	A	A	A	B	A	A	C	-	D	-	-	A	A	-	-	-
Calcium Sulfate	C	D	A	A	B	A	A	A	B	A	B	B	C	-	A	A	-	B	A	A	A	A
Calgon	-	A	A	-	-	-	A	A	A	A	A	A	B	-	C	D	-	-	-	-	-	-
Cane Juice	-	A	C	A	A	A	A	A	A	A	A	A	B	-	A	A	-	-	-	-	-	-
Carbolic Acid (Phenol)	D	D	B	A	D	A	D	B	D	A	B	B	A	D	B	D	D	A	A	A	A	-
Carbon Bisulfide	-	A	D	-	D	-	-	D	D	A	A	B	B	-	B	-	-	-	-	-	-	-
Carbon Dioxide (dry)	B	A	A	A	A	A	A	B	B	B	A	A	B	B	A	D	-	A	A	A	-	-
Carbon Dioxide (wet)	B	A	A	A	A	A	A	B	B	B	A	A	A	-	A	D	-	A	A	A	A	-
Carbon Disulfide	-	A	D	A	D	B	D	D	D	A	A	B	A	-	D	A	-	B	B	A	-	-
Carbon Monoxide	-	A	A	A	A	B	A	A	D	A	A	A	A	-	A	A	A	B	-	A	-	-
Carbon Tetrachloride	D	B	D	A	D	A	D	D	D	A	B	B	D	-	A	D	A	A	A	A	A	A
Carbon Tetrachloride (dry)	D	-	D	A	-	A	C	B	D	A	B	B	D	A	B	-	-	B	A	A	A	A
Carbon Tetrachloride (wet)	D	A	D	A	-	A	D	D	D	A	A	A	D	B	A	C	-	B	A	A	A	-
Carbonated Water	-	A	B	A	A	-	A	A	A	A	A	A	A	D	A	D	B	-	-	-	-	-
Carbonic Acid	-	B	A	A	A	A	D	B	C	A	A	A	B	D	B	D	-	A	B	A	A	-
Catsup	B	B	A	-	A	-	A	A	-	A	A	A	D	-	A	D	D	-	-	-	-	-
Chloric Acid	-	D	-	A	A	-	-	-	-	-	D	-	D	-	D	D	D	-	-	D	-	-
Chlorinated Glue	-	D	-	-	-	-	B	B	-	A	-	A	-	-	A	D	-	-	-	-	-	-
Chlorine Water	-	D	D	A	A	B	D	C	C	A	C	C	D	D	B	-	D	A	A	A	A	A
Chlorine, Anhydrous Liquid	-	A	D	A	D	A	D	B	C	A	C	C	D	D	D	D	-	D	D	A	-	C
Chlorine (dry)	-	D	D	A	D	A	B	A	D	A	A	B	C	D	B	D	A	A	D	A	-	-
Chloroacetic Acid	-	D	C	A	B	A	D	B	D	D	B	A	D	D	C	D	D	A	A	A	-	-
Chlorobenzene (Mono)	D	D	C	B	D	A	D	D	D	A	A	B	A	B	C	B	B	A	B	A	A	A
Chlorobromomethane	-	-	A	A	D	-	D	B	D	-	-	-	-	-	-	B	B	-	-	-	A	-
Chloroform	-	A	-	A	D	-	D	-	-	-	A	A	D	A	-	-	-	-	-	-	-	-
Chlorosulfuric Acid	-	-	-	-	-	-	-	-	-	-	-	-	-	-	-	-	-	-	-	-	-	-

RATING CHEMICAL BEHAVIOR
A No effect
B Minor effect
C Moderate effect
D Severe effect, not recommended
- No data available

TABLE 4	PLASTICS						ELASTOMERS				METALS								NO METALS			
	ABS Plastic	Acetal (DELRIN)	Polypropylene (PP)	PTFE (TEFLON)	PVC	PVDF (KYNAR)	Buna N	EPDM	Natural Rubber	VITON	AISI 304 S.S.	AISI 316 S.S.	Aluminium	Brass	Bronze	Cast Iron	Copper	Hastelloy C	Titanium	Carbon Graphite	Ceramic Al ₂ O ₃	Ceramic Magnet
Chocolate Syrup	-	-	-	-	-	-	-	-	-	-	-	-	-	-	-	-	-	-	-	-	-	-
Chromic Acid 5	-	D	-	A	-	-	A	-	-	A	-	D	-	D	-	-	-	-	-	-	-	-
Chromic Acid 10	-	-	-	-	-	-	-	-	-	-	-	-	-	-	-	-	-	-	-	-	-	-
Chromic Acid 30	-	-	-	-	-	-	-	-	-	-	-	-	-	-	-	-	-	-	-	-	-	-
Chromic Acid 50	-	-	-	-	-	-	-	-	-	-	-	-	-	-	-	-	-	-	-	-	-	-
Chromium Salts	-	-	-	-	-	-	-	-	-	-	-	-	-	-	-	-	-	-	-	-	-	-
Cider	-	-	-	-	-	-	-	-	-	-	-	-	-	-	-	-	-	-	-	-	-	-
Citric Acid	-	A	-	-	-	-	A	-	-	-	-	B	-	C	-	-	-	-	-	-	-	-
Citric Oils	-	-	-	-	-	-	-	-	-	-	-	-	-	-	-	-	-	-	-	-	-	-
Clorix (Bleach)	-	-	-	-	-	-	-	-	-	-	-	-	-	-	-	-	-	-	-	-	-	-
Coffee	-	-	A	A	-	A	A	-	-	-	A	A	-	-	-	-	-	A	-	-	-	-
Copper Chloride	-	-	-	-	-	-	A	A	A	D	-	A	-	-	-	D	D	A	-	-	-	-
Copper Cyanide	-	-	A	A	A	A	A	A	C	A	-	A	-	-	-	A	-	A	-	-	-	-
Copper Fluoborate	-	-	-	A	-	A	B	-	-	A	-	D	-	-	-	D	-	-	-	-	-	-
Copper Nitrate	-	-	-	-	-	-	C	C	A	A	-	A	-	-	-	D	-	B	-	-	-	-
Copper Sulfate 5	-	-	-	-	-	-	A	A	A	A	-	A	-	-	-	D	-	A	-	-	-	-
Copper Sulfate >5	-	-	-	-	-	-	-	-	-	-	-	-	-	-	-	-	-	-	-	-	-	-
Cream	-	-	A	A	-	-	A	-	-	A	-	A	-	-	-	D	-	-	-	-	-	-
Cresols	-	-	D	-	A	-	D	D	D	C	-	D	-	-	-	A	-	-	-	-	-	-
Cresylic Acid	-	D	C	A	-	-	C	D	D	A	-	A	-	-	-	D	-	B	-	-	-	-
Cupric Acid	-	-	-	-	-	-	-	-	-	-	-	-	-	-	-	-	-	-	-	-	-	-
Cyanic Acid	-	-	-	-	-	-	C	-	-	-	-	A	-	-	-	D	-	-	-	-	-	-
Cyclohexane	-	-	A	A	D	D	B	C	D	B	-	B	-	-	-	B	-	C	-	-	-	-
Cyclohexanone	-	-	D	A	-	A	D	C	D	A	-	B	-	-	-	B	-	B	-	-	-	-
Detergents	-	-	-	-	-	-	A	B	-	A	-	A	-	-	-	A	-	-	-	-	-	-
Diacetone Dialcohol	-	-	D	-	-	A	D	-	-	D	-	A	-	-	-	A	-	-	-	-	-	-
Dichlorobenzene	-	-	B	A	-	A	D	D	D	A	-	B	-	-	-	B	-	A	-	-	-	-
Dichloroethane	-	-	-	-	-	-	-	-	-	-	-	-	-	-	-	-	-	-	-	-	-	-
Diesel Fuel	-	-	A	A	A	A	A	D	D	A	-	A	-	-	-	A	-	A	-	-	-	-
Diethyl Ether	-	-	-	A	-	A	B	D	D	D	-	A	-	-	-	A	-	A	-	-	-	-
Diethylamine	-	-	-	-	-	-	-	-	-	-	-	-	-	-	-	-	-	-	-	-	-	-
Diethylene Glycol	-	-	A	A	A	A	A	A	A	A	-	A	-	-	-	A	-	A	-	-	-	-
Dimethyl Aniline	-	-	A	A	-	A	D	C	D	C	-	-	-	-	-	B	-	-	-	-	-	-
Dimethyl Formamide	-	-	A	A	-	A	C	B	B	A	-	A	-	-	-	A	-	A	-	-	-	-
Diphenyl	-	-	-	A	-	A	D	D	D	A	-	B	-	-	-	B	-	-	-	-	-	-
Diphenyl Oxide	-	-	-	A	-	B	D	D	D	A	-	A	-	-	-	A	-	A	-	-	-	-
Dyes	-	-	-	A	-	-	-	-	-	B	-	A	-	-	-	-	-	-	-	-	-	-
Epsom Salts (Magnesium Sulfate)	-	-	-	A	-	A	A	A	-	-	-	A	-	-	-	-	-	B	-	-	-	-
Ethane	-	-	D	A	-	A	A	D	D	A	-	A	-	-	-	A	-	A	-	-	-	-
Ethanol	-	-	A	A	B	A	A	A	A	D	-	A	-	-	-	A	-	A	-	-	-	-
Ethanolamine	-	-	D	A	-	B	B	B	-	D	-	A	-	-	-	A	-	-	-	-	-	-
Ether	-	-	C	A	-	A	B	-	D	D	-	A	-	-	-	A	-	A	-	-	-	-
Ethyl Acetate	-	A	C	A	D	B	D	C	B	D	-	B	-	A	-	A	-	A	-	-	-	-
Ethyl Benzoate	-	-	B	A	-	-	-	C	-	A	-	A	-	-	-	A	-	A	-	-	-	-
Ethyl Chloride	-	-	D	A	-	A	A	A	-	A	-	A	-	-	-	B	-	B	-	-	-	-

RATING CHEMICAL BEHAVIOR

- A** No effect
- B** Minor effect
- C** Moderate effect
- D** Severe effect, not recommended
- No data available

TABLE 5	PLASTICS					ELASTOMERS				METALS								NO METALS				
	ABS Plastic	Acetal (DEL RIN)	Polypropylene (PP)	PTFE (TEFLON)	PVC	PVDF (KYNAR)	Buna N	EPDM	Natural Rubber	VITON	AISI 304 S.S.	AISI 316 S.S.	Aluminium	Brass	Bronze	Cast Iron	Copper	Hastelloy C	Titanium	Carbon Graphite	Ceramic Al ₂ O ₃	Ceramic Magnet
Ethyl Ester	-	-	-	A	-	-	A	A	-	A	-	D	-	-	-	-	-	-	-	-	-	-
Ethyl Sulfate	-	-	-	-	-	-	-	-	-	-	-	-	-	-	-	-	-	-	-	-	-	-
Ethylene Bromide	-	-	-	-	-	A	B	-	-	A	-	A	-	-	-	C	-	-	-	-	-	-
Ethylene Chloride	-	-	-	-	-	-	-	-	-	-	-	-	-	-	-	-	-	-	-	-	-	-
Ethylene Chlorohydrin	-	-	D	A	-	A				D	-	B	-	-	-	B	-	-	-	-	-	-
Ethylene Diamine	-	-	A	A	A	A	D	B	D	B	-	A	-	-	-	A	-	A	-	-	-	-
Ethylene Dichloride	-	-	A	A	A	A	A	A	B	A	-	A	-	-	-	A	-	A	-	-	-	-
Ethylene Glycol	-	-	D	A	-	A	D	C	-	D	-	A	-	-	-	B	-	A	-	-	-	-
Ethylene Oxide	-	-	B	A	-	A	B	-	-	A	-	A	-	-	-	D	-	A	-	-	-	-
Fatty Acids	-	-	A	A	-	A	A	A	-	A	-	D	-	-	-	D	-	A	-	-	-	-
Ferric Chloride	-	-	A	A	-	A	A	A	-	A	-	B	-	-	-	-	-	A	-	-	-	-
Ferric Nitrate	-	-	A	A	A	A	B	A	-	A	-	B	-	-	-	D	-	A	-	-	-	-
Ferric Sulfate	-	-	A	A	-	A	B	A	-	A	-	C	-	-	-	D	-	B	-	-	-	-
Ferrous Chloride	-	-	A	A	-	A	B	A	-	A	-	B	-	-	-	D	-	A	-	-	-	-
Ferrous Sulfate	-	-	A	A	-	A	A	A	A	A	-	B	-	-	-	D	-	-	-	-	-	-
Fluoboric Acid	-	-	D	A	-	A	D	C	-	B	-	A	-	-	-	D	-	-	-	-	-	-
Fluorine	-	-	B	A	A	A	B	B	-	A	-	C	-	-	-	D	-	B	-	-	-	-
Fluosilic Acid	-	-	A	A	-	A	B	A	-	A	-	A	-	-	-	D	-	A	-	-	-	-
Formaldehyde 40	-	-	A	A	-	A	B	A	-	A	-	A	-	-	-	D	-	A	-	-	-	-
Formaldehyde 100	-	-	A	A	-	A	C	B	C	B	-	B	-	-	-	D	-	A	-	-	-	-
Formic Acid	-	-	-	A	-	A	C	D	B	C	-	A	-	-	-	B	-	-	-	-	-	-
Freon 11	-	-	B	A	-	A	-	-	A	B	-	A	-	-	-	A	-	-	-	-	-	-
Freon 12	-	-	D	-	-	A	A	A	-	D	-	A	-	-	-	D	-	-	-	-	-	-
Freon 22	-	-	D	A	-	A	B	C	C	B	-	A	-	-	-	-	-	-	-	-	-	-
Freon 113	-	-	-	-	-	B	A	D	C	B	-	A	-	-	-	A	-	-	-	-	-	-
Freon TF	-	-	A	A	A	A	A	A	A	A	-	A	-	-	-	D	-	A	-	-	-	-
Fruit Juice	-	-	A	A	A	A	A	-	-	A	-	A	-	-	-	A	-	A	-	-	-	-
Fuel Oils	-	-	C	A	-	D	D	C	D	C	-	A	-	-	-	-	-	-	-	-	-	-
Furan Resin	-	-	D	A	-	B	D	B	C	D	-	A	-	-	-	B	-	B	-	-	-	-
Furfural	-	-	A	A	-	A	B	B	A	A	-	B	-	-	-	D	-	B	-	-	-	-
Gallic Acid	-	-	-	-	-	-	-	-	-	-	-	-	-	-	-	-	-	-	-	-	-	-
Gasoline (high-aromatic)	-	-	D	A	-	A	A	-	-	A	-	A	-	-	-	A	-	A	-	-	-	-
Gasoline, leaded, ret	-	-	D	A	-	C	D	-	-	A	-	A	-	-	-	A	-	A	-	-	-	-
Gasoline, unleaded	-	-	A	A	-	A	A	A	-	B	-	A	-	-	-	C	-	-	-	-	-	-
Gelatin	-	-	A	A	-	A	A	A	A	A	-	A	-	-	-	B	-	-	-	-	-	-
Glucose	-	-	B	-	-	A	A	B	-	A	-	B	-	-	-	A	-	A	-	-	-	-
Glue P.V.A	-	-	A	-	-	A	A	A	A	A	-	A	-	-	-	B	-	A	-	-	-	-
Glycerin	-	-	A	A	-	A	A	A	-	A	-	-	-	-	-	-	-	A	-	-	-	-
Glycolic Acid	-	-	-	-	-	-	-	-	-	-	-	-	-	-	-	-	-	-	-	-	-	-
Gold Monocyanide	-	-	A	A	-	A	C	-	-	A	-	A	-	-	-	D	-	-	-	-	-	-
Grape Juice	-	-	-	A	-	A	A	A	-	A	-	A	-	-	-	A	-	-	-	-	-	-
Grease	-	-	C	A	-	A	A	-	-	A	-	A	-	-	-	A	-	A	-	-	-	-
Heptane	-	-	C	-	-	A	B	C	A	A	-	A	-	-	-	A	-	-	-	-	-	-
Hexane	-	-	A	A	-	A	A	-	-	A	-	A	-	-	-	A	-	-	-	-	-	-
Honey	-	-	A	A	-	-	A	-	-	A	-	A	-	-	-	A	-	-	-	-	-	-

This table to be completed in next printing, please call for update version.

PIPING

Flange standards	31
Economic pipe sizes	33
Water flow in steel pipes	34

FLANGE STANDARDS

BLIND FLANGES TO DIN 2527

DN	ND 6 (DIN 2527)					
	Flange			Holes		
	D	t	W	N	Ø	a
10	75	12	0,38	4	11	50
15	80	12	0,44	4	11	55
20	90	14	0,65	4	11	65
25	100	14	0,82	4	11	75
32	120	14	1,17	4	14	90
40	130	14	1,39	4	14	100
50	140	14	1,62	4	14	110
65	160	14	2,14	4	14	130
80	190	16	3,43	4	18	150
100	210	16	4,22	4	18	170
125	240	18	6,11	8	18	200
150	265	18	7,51	8	18	225
175	295	20	10,20	8	18	255
200	320	20	12,30	8	18	280
250	375	22	18,50	12	18	335
300	440	22	25,50	12	22	395
350	490	22	31,80	12	22	445
400	540	22	38,50	16	22	495
450	595	22	47,00	16	22	550
500	645	24	60,40	20	22	600
PN 6 (UNI 6091)						

DN	ND 10 (DIN 2527)					
	Dimensions			Holes		
	D	t	W	N	Ø	a
90	14	0,63	4	14	60	
95	14	0,71	4	14	65	
105	16	1,01	4	14	75	
115	16	1,22	4	14	85	
140	16	1,80	4	18	100	
150	16	2,09	4	18	110	
165	18	2,87	4	18	125	
185	18	3,65	4	18	145	
200	20	4,61	4	18	160	
220	20	5,65	8	18	180	
250	22	8,12	8	18	210	
285	22	10,50	8	22	240	
315	24	14,10	8	22	270	
340	24	16,50	8	22	295	
395	26	24,10	12	22	350	
445	26	30,80	12	22	400	
505	26	39,60	16	22	460	
565	26	49,60	16	25	515	
615	26	58,60	20	25	565	
670	28	75,30	20	25	620	
PN 10 (UNI 6092)						

DN	ND 16 (DIN 2527)					
	Dimensions			Holes		
	D	t	W	N	Ø	a
90	14	0,63	4	14	60	
95	14	0,71	4	14	65	
105	16	1,01	4	14	75	
115	16	1,22	4	14	85	
140	16	1,80	4	18	100	
150	16	2,09	4	18	110	
165	18	2,87	4	18	125	
185	18	3,65	4	18	145	
200	20	4,61	8	18	160	
220	20	5,65	8	18	180	
250	22	8,12	8	18	210	
285	22	10,50	8	22	240	
315	24	14,10	8	22	270	
340	24	16,20	12	22	295	
405	28	25,10	12	25	355	
460	28	35,20	12	25	410	
520	30	48,20	16	25	470	
580	32	63,50	16	30	525	
640	32	77,20	20	30	585	
715	34	102,0	20	33	650	
PN 16 (UNI 6093)						

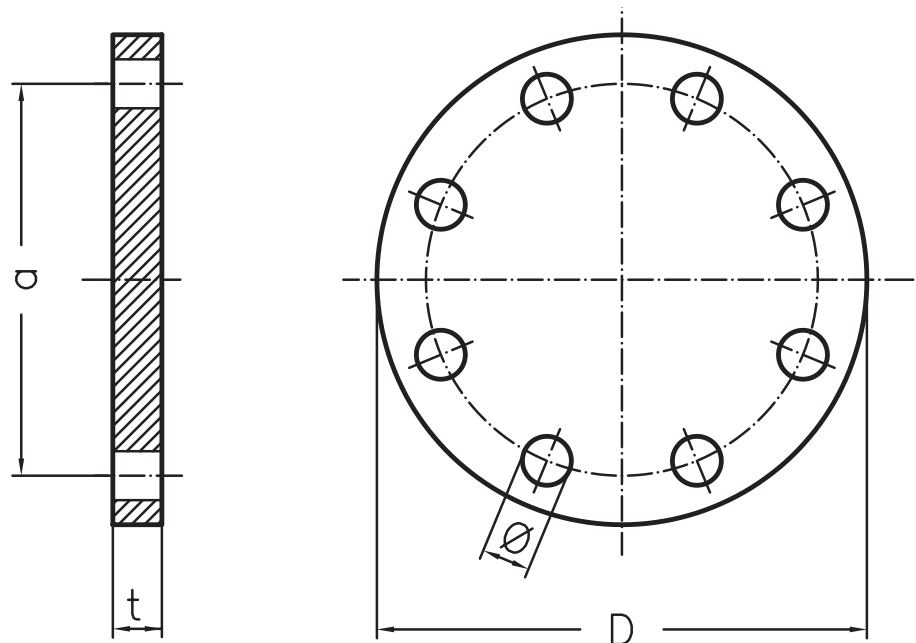

Legend:

- DN:** Nominal Diameter
- D:** Flange External Diameter
- t:** Flange Thickness
- W:** Flange Weight
- N:** Hole Number
- Ø:** Hole Diameter
- a:** Hole axis

FLANGE STANDARDS

FLANGES TO ANSI NORMS

DN	ANSI 150 lb					
	Flange			Holes		
	D	t	W	N	Ø	a
1/2"	88,9	11,1	0,8	4	15,9	60,3
3/4"	98,4	12,7	0,9	6	15,9	69,8
1"	107,9	14,3	1,0	4	15,9	79,4
1 1/4"	117,5	15,9	1,3	4	15,9	88,9
1 1/2"	127,0	17,5	1,4	4	15,9	98,4
2"	152,4	19,0	1,8	4	19,0	120,6
2 1/2"	177,8	22,2	3,2	4	19,0	139,7
3"	190,5	23,8	4,1	4	19,0	152,4
3 1/2"	215,9	23,8	5,9	8	19,0	177,8
4"	228,6	23,8	7,7	8	19,0	190,5
5"	254,0	23,8	9,1	8	22,2	215,9
6"	279,4	25,4	11,8	8	22,2	241,3
8"	342,9	28,6	20,4	8	22,2	298,4
10"	406,4	30,2	31,8	12	25,4	361,9
12"	482,6	31,7	50,0	12	25,4	431,8
14"	533,4	34,9	60,0	12	28,6	476,2
16"	596,9	36,5	77,0	16	28,6	539,7
18"	635,0	39,7	95,0	16	31,7	577,8
20"	698,5	42,9	123,0	20	31,7	635,0
22"	749,3	46,0	151,0	20	34,9	692,1

ANSI 300 lb						
Dimensions			Holes			
D	t	W	N	Ø	a	
95,2	14,3	1,0	4	15,9	66,7	
117,5	15,9	1,4	4	19,0	82,5	
123,8	17,5	1,8	4	19,0	88,9	
133,3	19,0	2,7	4	19,0	98,4	
155,6	20,6	3,2	4	22,0	114,3	
165,1	22,2	3,6	8	19,0	127,0	
190,5	25,4	5,4	8	22,2	149,2	
209,5	28,6	7,3	8	22,2	168,3	
228,6	30,2	9,5	8	22,2	184,1	
254,0	31,7	12,2	8	22,2	200,0	
279,4	34,9	15,9	8	22,2	234,9	
317,5	36,5	22,7	12	22,2	269,9	
381,0	41,3	37,0	12	25,4	330,2	
444,5	47,6	58,0	16	28,6	387,3	
520,7	50,8	84,0	16	31,7	450,8	
584,2	54,0	107,0	20	31,7	514,3	
647,7	57,1	139,0	20	34,9	571,5	
711,2	60,3	390,0	24	34,9	628,6	
774,7	63,5	223,0	24	34,9	685,8	
838,2	66,7	270,0	24	41,3	742,9	

ANSI 400 lb						
Dimensions			Holes			
D	t	W	N	Ø	a	
95,2	14,3	1,0	4	15,9	66,7	
117,5	15,9	1,4	4	19,0	82,5	
123,8	17,5	1,8	4	19,0	88,9	
133,3	20,6	2,7	4	19,0	98,4	
155,6	22,2	3,6	4	22,2	114,3	
165,1	25,4	4,5	8	19,0	127,0	
190,5	28,6	6,8	8	22,2	149,2	
209,5	31,7	9,1	8	22,2	168,3	
228,6	34,9	13,2	8	25,4	184,1	
254,0	34,9	15,0	8	25,4	200,0	
279,4	38,1	20,0	8	25,4	234,9	
317,5	41,3	27,7	12	25,4	269,9	
381,0	47,6	45,0	12	28,6	330,2	
444,5	54,0	70,0	16	31,7	387,3	
520,7	57,1	103	16	34,9	450,8	
584,2	60,3	141	20	34,9	514,3	
647,7	63,5	181	20	38,1	571,5	
711,2	66,7	228	24	38,1	628,6	
774,7	69,8	282	24	41,3	685,8	
838,2	73,0	311	24	44,4	742,9	

Legend:

- DN:** Nominal Diameter
- D:** Flange External Diameter
- t:** Flange Thickness
- W:** Flange Weight
- N:** Hole Number
- Ø:** Hole Diameter
- a:** Hole axis

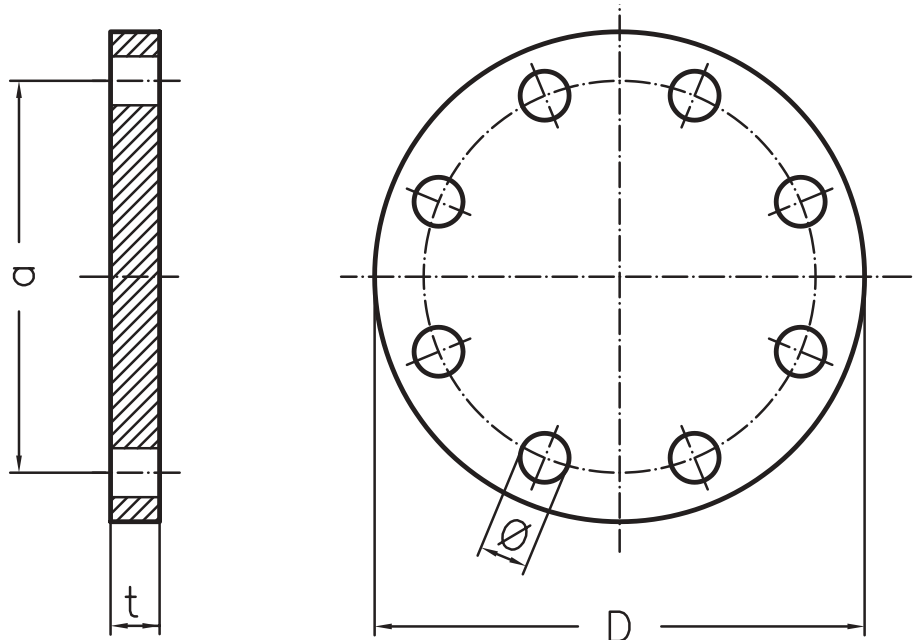

ECONOMIC PIPE SIZE

The following **Specific Pressure Drops (P)** are normally used in good engineering practice:

<i>Not boiling water.</i>	$P = 0.2 \div 0.5$ bar/100 m	for pump discharge (0.7 bar/100 m max, if $P > 50$ bar)
	$P < 0.110$ bar/100 m	for pump suction
<i>Boiling water.</i>	$P = 0.04 \div 0.05$ bar/100 m	for pump suction (velocity = $0.3 \div 0.9$ m/s)

For pipe sizing the Velocity (V) is also used.

In the following table are shown the typical liquid velocities in steel pipes.

LIQUID	LINE TYPE	VELOCITY [m/s] In Nominal pipe size [in]		
		2 or less	3 to 10	10 to 20
NOT BOILING WATER	Pump suction	$0.3 \div 0.6$	$0.6 \div 1.2$	$0.9 \div 1.8$
	Pump discharge (long)	$0.6 \div 0.9$	$0.9 \div 1.5$	$1.2 \div 2.1$
	Discharge leads (short)	$1.2 \div 2.7$	$1.5 \div 3.7$	$2.4 \div 4.2$
	Boiler feed	$1.2 \div 2.7$	$1.5 \div 3.7$	$2.4 \div 4.2$
	Drains	$0.9 \div 1.2$	$0.9 \div 1.5$	-
	Sloped sewer	-	$0.9 \div 1.5$	$1.2 \div 2.1$
HYDROCARBON LIQUIDS (normal viscosity)	Pump suction	$0.5 \div 0.8$	$0.6 \div 1.2$	$0.9 \div 1.8$
	Discharge heater (long)	$0.8 \div 1.1$	$0.9 \div 1.5$	$1.2 \div 2.1$
	Discharge leads (short)	$1.2 \div 2.7$	$1.5 \div 3.7$	$2.4 \div 4.6$
	Drains	$0.9 \div 1.2$	$0.9 \div 1.5$	-
MEDIUM VISCOSITY OIL	Pump suction	-	$0.5 \div 0.9$	$0.8 \div 1.5$
	Discharge (short)	-	$0.1 \div 0.2$	$0.1 \div 0.3$
	Drains	0.3	$0.9 \div 1.5$	$1.2 \div 1.8$
OTHER WATER	Cooling tower, Chilled water, Sea water and generally fouling water (long pipes) (*)	$0.6 \div 0.9$	$0.9 \div 1.5$	$1.2 \div 2.1$
Note: (*) In this case Cameron method has to be used with $C=1$.		$P = 0.05 \div 0.12$ bar/100 m for principal manifold $P = 0.12 \div 0.23$ bar/100 m for secondary manifold		

Some fixed pressure drop values indications:

- for gate valves (fully open) consider a pressure drop of 5 meters
- for normal bends consider a pressure drop of 5 meters
- for a check valve consider a pressure drop of 15 meters

In the succeeding tables we show the velocity and specific pressure drop for several flow rates and pipe diameters.

WATER FLOW IN CLEAN STEEL PIPE SCHED. 10S

Q	V	P	V	P	V	P	V	P	V	P	V	P	V	P	V	P
[l/min]	[m/s]	[bar]	[m/s]	[bar]	[m/s]	[bar]	[m/s]	[bar]	[m/s]	[bar]	[m/s]	[bar]	[m/s]	[bar]	[m/s]	[bar]
	1/8"		1/4"													
1	0,350	0,370	0,200	0,090	3/8"		1/2"									
2	0,705	1,340	0,395	0,331	0,223	0,082	0,145	0,029	3/4"							
3	1,060	2,890	0,593	0,673	0,333	0,176	0,217	0,061	0,125	0,016	1"					
4	1,410	4,940	0,788	1,150	0,444	0,291	0,290	0,101	0,167	0,027	0,110	0,010				
5	1,760	7,460	0,985	1,750	0,556	0,424	0,362	0,149	0,209	0,040	0,137	0,014				
6			1,180	2,460	0,667	0,594	0,434	0,207	0,251	0,054	0,165	0,019	1 1/4"			
8			1,580	4,060	0,892	1,020	0,579	0,351	0,335	0,091	0,219	0,033	0,126	0,009	1 1/2"	
10					1,110	1,530	0,724	0,534	0,418	0,136	0,274	0,049	0,158	0,012	0,116	0,006
15					1,670	3,250	1,090	1,130	0,627	0,284	0,411	0,099	0,236	0,026	0,174	0,012
20	2"				2,230	5,600	1,450	1,900	0,836	0,481	0,549	0,168	0,315	0,043	0,233	0,021
30	0,212	0,013	2 1/2"				2,170	4,130	1,250	1,020	0,823	0,353	0,473	0,092	0,348	0,043
40	0,283	0,022	0,190	0,007			2,900	7,180	1,670	1,760	1,100	0,606	0,631	0,155	0,465	0,073
50	0,354	0,032	0,237	0,012					2,090	2,700	1,370	0,911	0,789	0,233	0,581	0,108
60	0,424	0,044	0,284	0,017					2,510	3,810	1,650	1,290	0,943	0,321	0,697	0,150
70	0,495	0,079	0,332	0,022	3"				2,930	5,120	1,920	1,720	1,11	0,434	0,814	0,199
80	0,566	0,074	0,379	0,028	0,248	0,010	3 1/2"				2,190	2,210	1,26	0,554	0,925	0,253
90	0,636	0,093	0,427	0,035	0,279	0,013	0,209	0,006			2,470	2,770	1,42	0,692	1,040	0,319
100	0,707	0,114	0,474	0,043	0,310	0,015	0,232	0,007	4"		2,740	3,400	1,58	0,843	1,160	0,392
150	1,060	0,238	0,711	0,090	0,464	0,031	0,349	0,016	0,272	0,008	4,110	7,440	2,36	1,81	1,740	0,828
200	1,410	0,414	0,948	0,153	0,619	0,053	0,466	0,027	0,362	0,014			3,15	3,14	2,330	1,450
250	1,760	0,625	1,190	0,233	0,774	0,080	0,581	0,040	0,453	0,021	5"				2,900	2,200
300	2,120	0,889	1,420	0,324	0,930	0,112	0,698	0,055	0,543	0,030	0,352	0,011			3,480	3,070
350	2,470	1,190	1,660	0,438	1,080	0,150	0,815	0,074	0,634	0,040	0,411	0,014	6"		4,070	4,160
400	2,830	1,550	1,900	0,563	1,240	0,195	0,935	0,096	0,724	0,051	0,469	0,018	0,341	0,007	4,650	5,380
450	3,180	1,930	2,130	0,707	1,390	0,242	1,050	0,120	0,815	0,063	0,528	0,022	0,366	0,009	5,230	6,790
500	3,540	2,380	2,370	0,867	1,550	0,298	1,170	0,147	0,902	0,076	0,587	0,027	0,407	0,011		
550	3,880	2,870	2,610	1,040	1,700	0,354	1,280	0,174	0,991	0,092	0,645	0,032	0,447	0,013		
600	4,240	3,390	2,840	1,220	1,860	0,418	1,400	0,204	1,090	0,110	0,704	0,037	0,488	0,015		
650	4,590	5,560	3,080	1,420	2,010	0,486	1,510	0,239	1,180	0,127	0,762	0,043	0,529	0,017		
700	4,950	4,550	3,320	1,650	2,170	0,560	1,630	0,275	1,270	0,146	0,821	0,050	0,569	0,020		
750	5,300	5,200	3,560	1,880	2,320	0,637	1,750	0,314	1,360	0,164	0,879	0,057	0,610	0,023		
800			3,790	2,130	2,480	0,721	1,860	0,354	1,450	0,185	0,936	0,064	0,651	0,025	8"	
850			4,030	2,390	2,630	0,805	1,980	0,395	1,540	0,209	1,000	0,072	0,692	0,028	0,403	0,007
900					2,790	0,901	2,090	0,438	1,630	0,232	1,050	0,008	0,732	0,032	0,427	0,008
950					2,940	1,000	2,210	0,486	1,720	0,258	1,120	0,087	0,773	0,036	0,451	0,010
1000					3,100	1,110	2,320	0,534	1,810	0,284	1,170	0,096	0,814	0,039	0,474	0,011
1100					3,410	1,290	2,560	0,643	1,990	0,341	1,290	0,116	0,895	0,047	0,522	0,012
1200					3,720	1,580	2,800	0,763	2,170	0,403	1,410	0,135	0,974	0,055	0,569	0,015
1300							3,030	0,890	2,360	0,473	1,530	0,157	1,060	0,063	0,616	0,017
1400							3,260	1,020	2,540	0,544	1,640	0,183	1,140	0,072	0,664	0,019
1500							3,490	1,170	2,720	0,617	1,76	0,208	1,220	0,083	0,712	0,022
1600							3,720	1,330	2,890	0,697	1,880	0,234	1,300	0,093	0,758	0,025
1700	10"						3,950	1,490	3,080	0,784	1,990	0,260	1,380	0,104	0,806	0,028
1800	0,546	0,010							3,260	0,875	2,110	0,290	1,470	0,116	0,854	0,032
1900	0,575	0,012							3,440	0,965	2,230	0,323	1,550	0,129	0,901	0,034
2000	0,606	0,012							3,620	1,060	2,340	0,356	1,630	0,143	0,946	0,037
2200	0,667	0,015							3,980	1,280	2,580	0,429	1,790	0,172	1,050	0,045
2400	0,727	0,017	12"								2,820	0,507	1,950	0,200	1,140	0,053
2600	0,788	0,021	0,563	0,009							3,050	0,589	2,110	0,234	1,230	0,061
2800	0,848	0,023	0,606	0,010	14"						3,280	0,676	2,280	0,268	1,330	0,070
3000	0,909	0,026	0,649	0,011	0,532	0,007					3,520	0,773	2,440	0,306	1,420	0,080
3500	1,060	0,035	0,760	0,015	0,620	0,009					4,110	1,05	2,850	0,416	1,660	0,108
4000	1,210	0,045	0,866	0,020	0,709	0,012	16"				4,690	1,35	3,250	0,532	1,900	0,139
4500	1,360	0,056	0,976	0,025	0,798	0,015	0,606	0,007					3,660	0,674	2,130	0,173
5000	1,520	0,069	1,080	0,029	0,886	0,018	0,674	0,009					4,070	0,822	2,370	0,212
6000	1,810	0,097	1,290	0,042	1,070	0,026	0,808	0,013	18"				4,880	1,160	2,850	0,301
7000	2,120	0,130	1,510	0,055	1,240	0,035	0,940	0,017	0,741	0,010			5,690	1,580	3,310	0,403
8000	2,420	0,168	1,730	0,072	1,420	0,045	1,080	0,022	0,847	0,012			6,510	2,050	3,790	0,525
9000	2,730	0,210	1,950	0,091	1,600	0,056	1,210	0,027	0,954	0,015					4,270	0,659
10000	3,030	0,257	2,170	0,111	1,770	0,067	1,350	0,033	1,050	0,019					4,740	0,801

Legend: Q: Water Flow Rate, V: Velocity, P: Pressure drop
Pressure drop in bar per 100 meters of straight pipe (water at ambient temperature)

WATER FLOW IN CLEAN STEEL PIPE SCHED. 40S

Q	V	P	V	P	V	P	V	P	V	P	V	P	V	P	V	P
[l/min]	[m/s]	[bar]	[m/s]	[bar]	[m/s]	[bar]	[m/s]	[bar]	[m/s]	[bar]	[m/s]	[bar]	[m/s]	[bar]	[m/s]	[bar]
	1/8"		1/4"													
1	0,458	0,726	0,251	0,170	3/8"		1/2"									
2	0,918	2,590	0,501	0,600	0,272	0,136	0,170	0,044	3/4"							
3	1,380	5,590	0,752	1,220	0,407	0,29	0,255	0,091	0,144	0,023	1"					
4	1,840	9,570	1,000	2,090	0,543	0,48	0,340	0,151	0,192	0,038	0,120	0,012				
5	2,290	14,450	1,250	3,180	0,679	0,70	0,425	0,223	0,241	0,057	0,150	0,017				
6			1,500	4,460	0,815	0,980	0,510	0,309	0,289	0,077	0,180	0,024	1 1/4"			
8			2,010	7,360	1,090	1,690	0,680	0,524	0,385	0,129	0,240	0,041	0,138	0,011	1 1/2"	
10					1,360	2,520	0,850	0,798	0,481	0,193	0,300	0,061	0,172	0,015	0,127	0,008
15					2,040	5,370	1,280	1,690	0,722	0,403	0,450	0,124	0,258	0,032	0,19	0,015
20	2"				2,720	9,240	1,700	2,840	0,962	0,683	0,600	0,210	0,344	0,054	0,254	0,026
30	0,231	0,016	2 1/2"				2,550	6,170	1,440	1,450	0,900	0,442	0,517	0,114	0,38	0,053
40	0,308	0,027	0,216	0,010			3,400	10,720	1,920	2,500	1,200	0,758	0,689	0,193	0,507	0,091
50	0,385	0,039	0,270	0,017					2,410	3,830	1,500	1,140	0,861	0,29	0,634	0,135
60	0,462	0,055	0,324	0,023					2,890	5,410	1,800	1,610	1,03	0,400	0,761	0,187
70	0,539	0,098	0,378	0,031	3"				3,370	7,270	2,100	2,150	1,210	0,541	0,888	0,248
80	0,616	0,092	0,432	0,039	0,28	0,014	3 1/2"				2,400	2,760	1,380	0,690	1,010	0,315
90	0,693	0,115	0,486	0,048	0,315	0,017	0,235	0,008			2,700	3,470	1,550	0,862	1,140	0,397
100	0,770	0,141	0,540	0,059	0,35	0,02	0,261	0,010	4"		3,000	4,250	1,720	1,050	1,270	0,488
150	1,150	0,295	0,810	0,125	0,524	0,042	0,392	0,021	0,304	0,011	4,500	9,300	2,580	2,260	1,900	1,030
200	1,540	0,512	1,080	0,212	0,699	0,072	0,523	0,036	0,405	0,019			3,440	3,910	2,540	1,810
250	1,920	0,773	1,350	0,322	0,874	0,108	0,653	0,053	0,507	0,028	5"				3,170	2,740
300	2,310	1,100	1,620	0,449	1,05	0,152	0,784	0,074	0,608	0,04	0,387	0,014			3,800	3,820
350	2,690	1,470	1,890	0,606	1,22	0,203	0,915	0,099	0,710	0,053	0,452	0,018	6"		4,440	5,180
400	3,080	1,920	2,160	0,780	1,4	0,264	1,050	0,128	0,811	0,068	0,516	0,023	0,375	0,009	5,070	6,690
450	3,460	2,390	2,430	0,979	1,57	0,328	1,180	0,161	0,912	0,084	0,581	0,028	0,402	0,012	5,710	8,450
500	3,850	2,950	2,700	1,200	1,75	0,403	1,310	0,196	1,010	0,101	0,646	0,034	0,447	0,014		
550	4,230	3,550	2,970	1,440	1,92	0,479	1,440	0,232	1,110	0,122	0,710	0,041	0,491	0,016		
600	4,620	4,200	3,240	1,690	2,100	0,566	1,570	0,273	1,220	0,146	0,775	0,047	0,536	0,019		
650	5,000	6,880	3,510	1,970	2,270	0,658	1,700	0,319	1,320	0,169	0,839	0,055	0,581	0,022		
700	5,390	5,630	3,780	2,280	2,450	0,759	1,830	0,368	1,420	0,194	0,904	0,063	0,625	0,025		
750	5,77	6,440	4,050	2,600	2,620	0,863	1,960	0,42	1,520	0,218	0,968	0,072	0,67	0,029		
800			4,320	2,950	2,800	0,977	2,090	0,473	1,620	0,246	1,030	0,081	0,715	0,032	8"	
850			4,590	3,310	2,970	1,090	2,220	0,528	1,720	0,277	1,100	0,091	0,76	0,036	0,439	0,009
900					3,150	1,220	2,350	0,585	1,820	0,308	1,160	0,100	0,804	0,041	0,465	0,01
950					3,320	1,350	2,48	0,649	1,930	0,342	1,230	0,111	0,849	0,045	0,491	0,012
1000					3,500	1,500	2,61	0,714	2,030	0,377	1,290	0,122	0,894	0,049	0,516	0,013
1100					3,850	1,750	2,870	0,860	2,230	0,452	1,420	0,147	0,983	0,059	0,568	0,015
1200					4,200	2,140	3,140	1,020	2,430	0,534	1,550	0,172	1,070	0,069	0,620	0,018
1300							3,400	1,190	2,640	0,627	1,680	0,200	1,160	0,08	0,671	0,021
1400							3,660	1,370	2,840	0,722	1,810	0,232	1,250	0,091	0,723	0,024
1500							3,920	1,560	3,040	0,818	1,940	0,264	1,340	0,105	0,775	0,027
1600							4,180	1,780	3,240	0,924	2,070	0,297	1,430	0,118	0,826	0,031
1700	10"						4,440	1,990	3,450	1,040	2,190	0,331	1,520	0,132	0,878	0,035
1800	0,590	0,012							3,650	1,160	2,320	0,369	1,610	0,147	0,930	0,039
1900	0,622	0,014							3,850	1,280	2,450	0,41	1,700	0,163	0,981	0,042
2000	0,655	0,015							40,500	1,410	2,580	0,452	1,790	0,181	1,030	0,046
2200	0,721	0,018							4,460	1,700	2,840	0,545	1,970	0,217	1,140	0,056
2400	0,786	0,021	12"								3,100	0,645	2,140	0,253	1,240	0,065
2600	0,852	0,025	0,600	0,01							3,360	0,749	2,320	0,296	1,340	0,076
2800	0,917	0,028	0,646	0,012	14"						3,610	0,859	2,500	0,339	1,450	0,087
3000	0,983	0,032	0,692	0,013	0,573	0,008					3,870	0,982	2,68	0,387	1,550	0,099
3500	1,150	0,043	0,810	0,018	0,668	0,011					4,520	1,330	3,130	0,526	1,810	0,134
4000	1,310	0,055	0,923	0,023	0,764	0,014	16"				5,160	1,720	3,570	0,673	2,070	0,172
4500	1,470	0,068	1,040	0,029	0,860	0,018	0,658	0,009					4,020	0,853	2,320	0,214
5000	1,640	0,084	1,150	0,034	0,955	0,022	0,731	0,011					4,470	1,040	2,580	0,262
6000	1,960	0,118	1,380	0,049	1,150	0,031	0,877	0,016	18"				5,360	1,470	3,100	0,373
7000	2,290	0,158	1,610	0,065	1,340	0,042	1,020	0,021	0,808	0,012			6,250	2,000	3,610	0,499
8000	2,620	0,204	1,840	0,085	1,530	0,054	1,170	0,027	0,924	0,015			7,150	2,590	4,130	0,65
9000	2,950	0,256	2,080	0,107	1,720	0,067	1,310	0,033	1,040	0,019					4,650	0,816
10000	3,280	0,313	2,310	0,130	1,910	0,081	1,460	0,041	1,150	0,023					5,160	0,992

Legend: Q: Water Flow Rate, V: Velocity, P: Pressure drop
Pressure drop in bar per 100 meters of straight pipe (water at ambient temperature)

PNR PRODUCT RANGE

PNR manufactures, in addition to the range of general purpose nozzles shown in this Catalog, a wide range of other products and systems allowing you to optimize the use of liquid spray and fluid control in most modern industrial processes. You find our high quality, proven products shown in the following catalogs:

CTG UG16 BR



General purpose nozzles Catalog

A complete range of spray nozzles to cope with most of today's requirements. Hydraulic nozzles, with full-cone, hollow cone, flat and needle jet in a range of dimensions and materials chosen for the specific application, with capacities from as low as 0.08 to 9.410 litres per minute. Designs for non-clogging operation, high impact jetting or limited dimensions nozzles, include all improvements developed from our experience on thousands of real application histories.

CTG SP10 BR

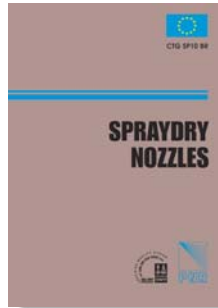

Spraydry nozzles

High pressure or air assisted, high quality metal or inside tungsten carbide lined, a complete line of nozzles to retrofit existing plants at competitive prices. Only the highest quality materials and the most precise machining are employed in the manufacture of our nozzles, to assure precisely defined results and consistent wear life.

CTG AC16 BR



Accessories Catalog

A complete line of nipples, clamps, swivel joints and everything that helps you to easily assemble, align and service your spraying systems. Air blowers, mixing eductors, filters, cleaning guns and lances, hose reels, steam heaters, pressure tanks, quick couplings to help you build up a professional system to the modern state of the art.

CTG PM09 BR

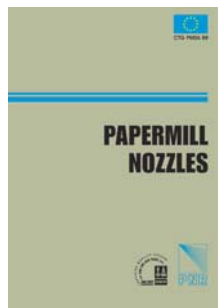

Papermill products

A sixteen page Catalog showing products specially developed for perfect results on paper making machines, including our patented disc nozzle for self-cleaning pipes, needle nozzles with sapphire and ruby orifice, oscillating pipes with high quality computer driven motor.

CTG LS15 BR

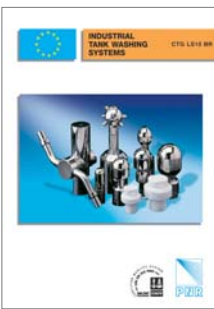

Tank washing systems

Everything from the simple fixed sprayballs and pintle nozzles to the two-axis washer, heads reaction driven, water driven, with electric or pneumatic motor. Professional inside surface cleaning of industrial tanks with the latest technology, together with state of the art accessories.

CTG SW11 BR

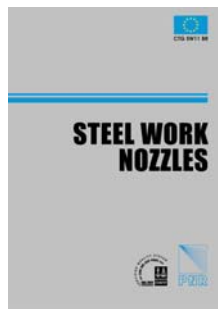

Steelwork nozzles

A complete line of nozzles for steelwork applications, including continuous casting air atomizers and conventional nozzles, descaling nozzles for high pressure systems, fixed position dovetail tips and coke quenching high capacity flanged nozzles.

CTG AZ15 BR



Air assisted atomizers

Ultrasonic, classic and automatic atomizers for the finest atomization in any process. High quality machining and tight quality control assure a professional result to your system, control cabinet and spray programmer allow for complete humidification systems to be easily assembled.

CTG LN16 BR

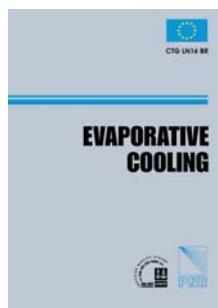

Gas cooling lances

Spillback or air assisted lances for gas cooling processes in steelwork, cement plants and any other industrial application. We can supply spare parts, retrofit your system or even supply a complete system, PLC driven, to upgrade tower performance to the latest technical stand.

CTG SH02 EU



Our products are distributed through:

PNR America
PNR Asia
PNR Baltic

PNR Benelux
PNR Czech Republic
PNR Deutschland
PNR France

PNR Italia
PNR Mexico
PNR U. Kingdom

We are moreover represented in:

Argentina
Australia
Austria
Canada
Chile
Denmark
Finland
Greece
India

Indonesia
Iran
Ireland
Japan
Slovenia
Korea
Nepal
Norway
N. Zealand

Pakistan
Poland
Portugal
Singapore
South Africa
Spain
Sweden
Taiwan
Venezuela